

SG 1014

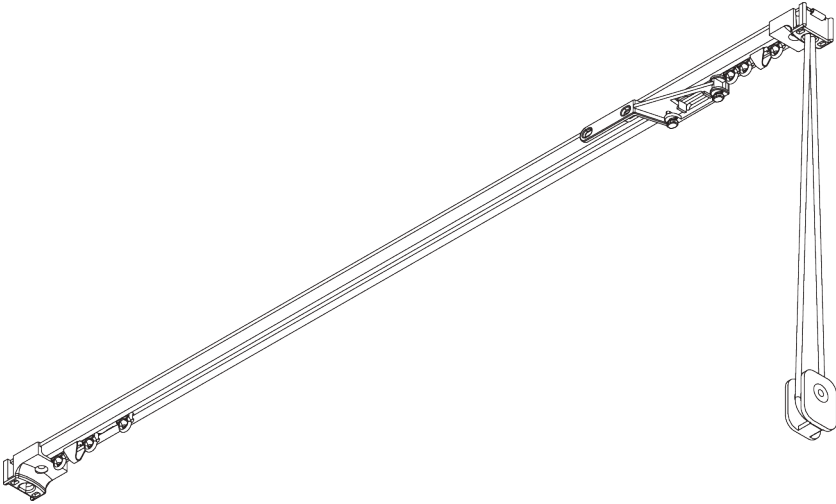

PRODUCT INFORMATION

- **Operation:** cord
- **Range:** S
- **Fitting:** ceiling
- **Colours:** white RAL 9016 or anodised aluminum, special colours possible
- **Fabrics:** refer to Silent Gliss fabric collection

Features:

- Pre-drilled profile
- Bendable
- Fitting tool center SG 7550

SYSTEM SPECIFICATIONS

A. SYSTEM DIMENSIONS

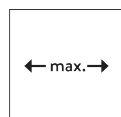

6 m

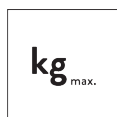

12 kg

Max. curtain weight

	2 m	4 m	6 m
	8	7	6
	11	10	8
	5	4	-
	6	5	-
	3	2	-
	5	4	-

(kg max.)

B. PROFILE

Profile and bending information

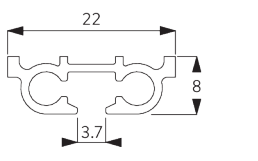

SG 1014p

Profile

Radius:
20 cm

C. HOW TO MEASURE

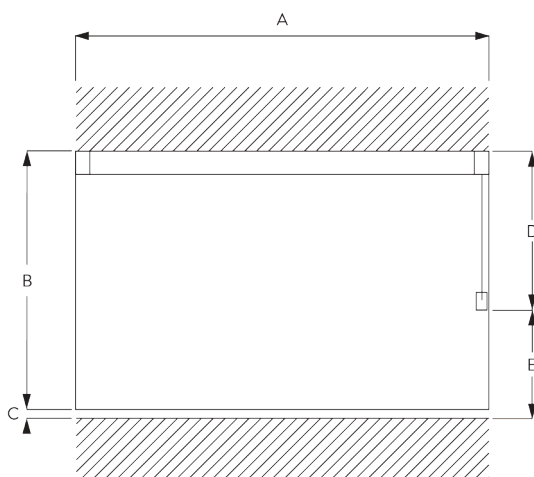

- A: System width
- B: System height
- C: Distance between floor and fabric
- D: Cord height
- E: Safety Retainer SG 10731 min. 150 cm above floor

FITTING

A. FITTING INFORMATION

For detailed fitting information, visit the Silent Gliss website.

Fixing points

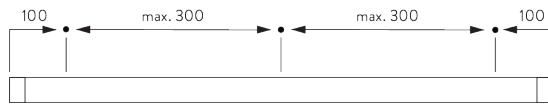

Fitting Tool

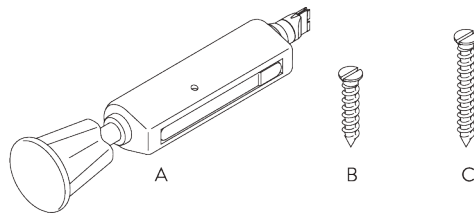

A: Center SG 7550 Tool
 B: Special Screw SG 3019 / 12 mm
 C: Special Screw SG 3025 / 18 mm

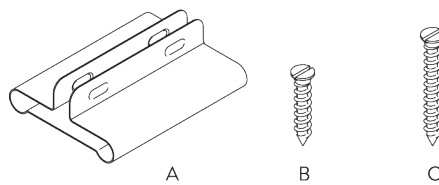

A: Profile Protector SG 7002
 B: Special Screw SG 3019 / 12 mm
 C: Special Screw SG 3025 / 18 mm

B. CEILING FITTING

Direct into wood

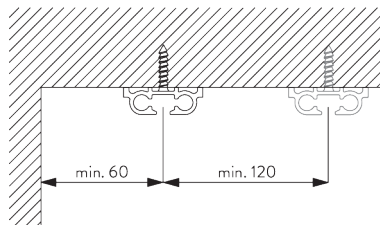

Bracket SG 3114

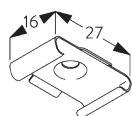
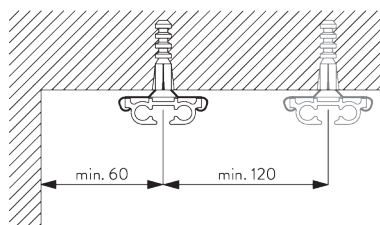

SG 3114
 Bracket

PARTS

A. STANDARD PARTS

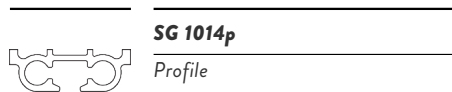

SG 1014p

Profile

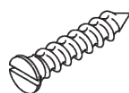

SG 3019

Special screw 12 mm

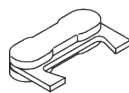

SG 3030

Pilot runner

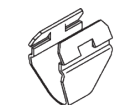

SG 3085

Spring stop



SG 3090

Cord \varnothing 3.5 mm

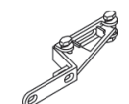

SG 3242

Overlap arm



SG 3533

Glider

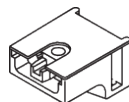

SG 3714

Cord guide



SG 10731

Child safety retainer set

B. OPTIONAL PARTS

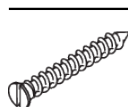

SG 3025

Special screw 18 mm

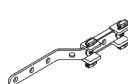

SG 3045

Overlap arm



SG 3070

End stop



SG 3114

Bracket



SG 3340

Cord/chain weight



SG 3534

Glider 3533 on strip



SG 3582

Hook



SG 3735

Cord weight with tensioner

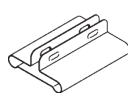

SG 7002

Profile protector

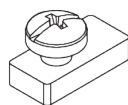

SG 11335

End stop