

# SG 6103

---

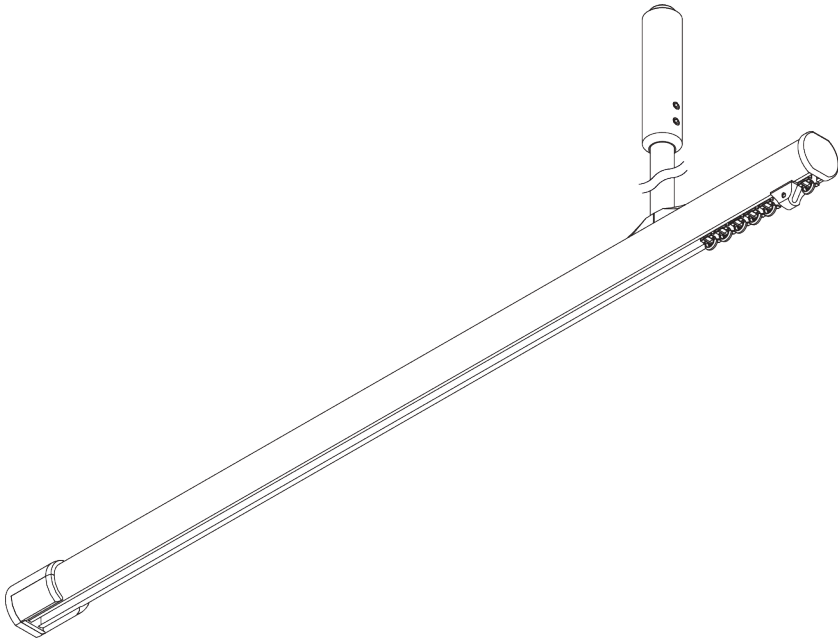
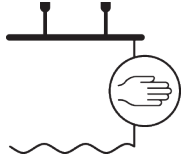

## PRODUCT INFORMATION

- **Operation:** hand
- **Range:** S - L
- **Fitting:** suspended, ceiling, wall
- **Colours:** white RAL 9016 or anodised aluminum, special colours possible
- **Fabrics:** refer to Silent Gliss fabric collection

### **Features:**

- Universal room divider
- 2-component (2C) glider technology
- Wave (2C)
- Suspended
- Versatile layouts
- Bendable

# SYSTEM SPECIFICATIONS

## A. PROFILE

Profile and bending information

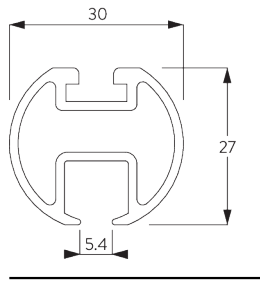

SG 6103p

Profile

Radius:  
>25 cm

## B. HOW TO MEASURE

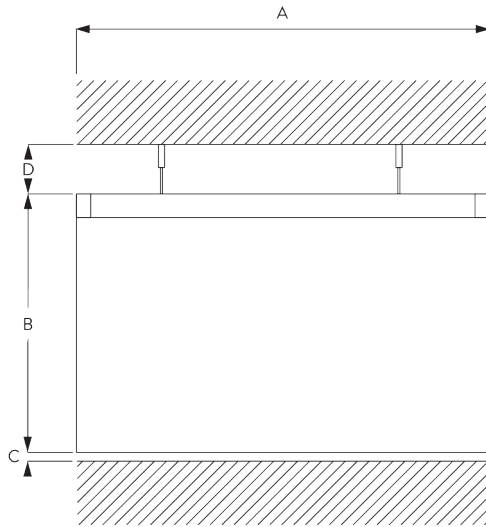

A: System width

B: System height

C: Distance between floor and fabric

D: Distance between ceiling and system

## C. SPECIFICATION

### TEXT

#### EN

Silent Gliss SG 6103 Cubicle Curtain Track System. Comprises aluminium profile SG 6103 supplied made to measure in silver anodised or powder coated in white. 2 stops SG 6065. 2 End caps SG 6630. Supplied with 2C gliders SG 11300/SG 6145 with hooks at 14/m. Top fixed with SG 6124//SG 6190 at 800-3000 mm centres. Wall fixed with SG Smart Fix at 800-3000 mm centres.

#### SV

Silent Gliss SG 6103 dusch/draperi system. Består av aluminiumprofil SG 6103 i specificerad längd i vitlack, alu natur eller angiven RAL färg. 14 st 11300 SILENT TRACK glid/SG 6145 glid m krok per meter. 2 SG 6065 vridstopp. Ändskydd SG 6630. Takmonteras med fäste SG 6124/SG 6190 c/c 800-3000 mm. Vägmontering med SG Smart Fix c/c 800-3000 mm.

#### NO

Silent Gliss SG 6103 Dusj- og Cubiclesystem. Består av aluminiumprofil SG 6103 i spesifisert lengde. Hvitlakkert eller alu natur eller spesifisert RAL farge. 14 stk SG 11300 SILENT TRACK glider/SG 6145 glider m/krok pr meter. 2 stk SG6065 vridstopp. Endelukk SG6630 Takmonteres med feste SG 6124/SG6190 c/c 800-3000 mm. Veggmontering med SG Smart Fix c/c 800-1500 mm.

#### DA

Silent Gliss SG 6103 gardinskinnesystem til kabiner. Består af en aluminiumprofil SG 6103 i ønsket længde, sølvanodiseret eller hvid pulverlakering. 2 stop SG 6065. 2 endelåg SG 6630. Leveres med 14 stk. 2C glidere SG 11300/SG 6145 pr m. Loftmonteres med SG 6124//SG 6190 i afstande på 800-3000 mm. Vægmonteres med SG Smart Fix med en afstand på 800-3000 mm.

# FITTING

## A. FITTING INFORMATION

### Fixing points

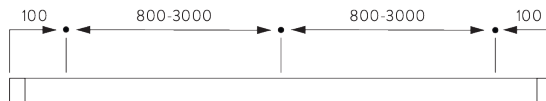

For detailed fitting information, visit the Silent Gliss website.

### Dust Cover

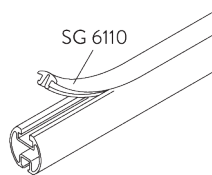

## B. CEILING FITTING

### Hanger SG 6190 / SG 6196

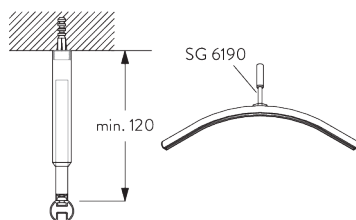

Or variant with SG 6196 double hanger.

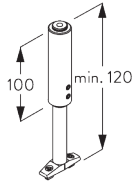

**SG 6190**  
Hanger

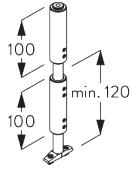

**SG 6196**  
Double hanger

**Mini hanger SG 6175**

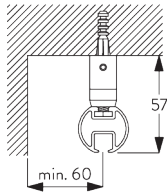

**SG 6175**  
Mini hanger

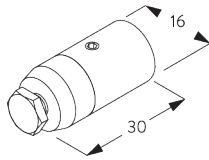

**Bracket SG 6124**

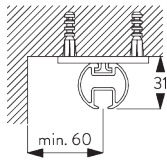

**SG 6124**  
Bracket

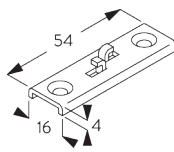

## V-hanger

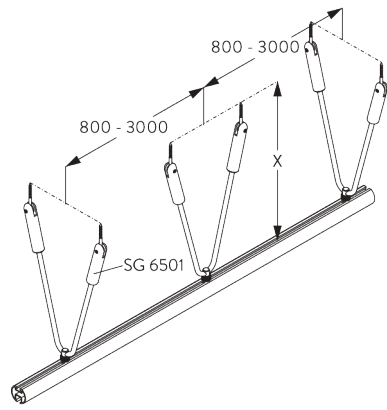

### **SG 6501:**

*V-hangers (25°-35°) provide additional lateral stability.*

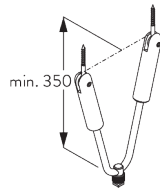

### **SG 6501**

*V-Hanger*

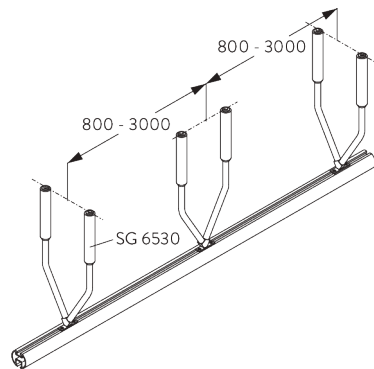

### **SG 6530:**

*V-hangers (25°-35°) provide additional lateral stability.*

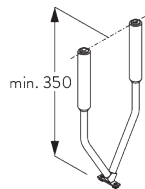

### **SG 6530**

*V-Hanger*

## C. WALL FITTING

### Smart Fix

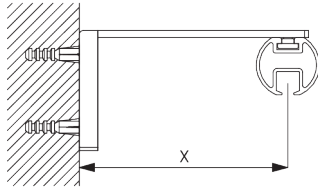

**Smart Fix with slot SG 11206 - SG 11208:**  
Screw SG 10492 (M4x8) needed.

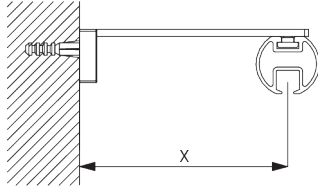

**Square Smart Fix with slot SG 11216 - SG 11218:**  
Screw SG 10492 (M4x8) needed.

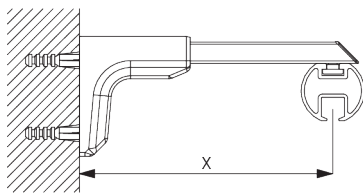

**Universal Smart Fix SG 11154 - SG 11156:**  
Screw SG 11131 (M4x6) needed.

| Smart Fix           | X mm    |
|---------------------|---------|
| SG 11206 / SG 11216 | 33-51   |
| SG 11207 / SG 11217 | 53-71   |
| SG 11208 / SG 11218 | 73-91   |
| SG 11154            | 102-130 |
| SG 11155            | 132-160 |
| SG 11156            | 182-210 |

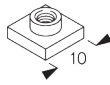

**SG 6117**  
Slot nut



**SG 10492**  
Pan head screw M4x8



**SG 11131**  
Pan head screw with flange  
M4x6

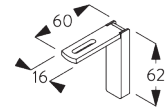

**SG 11206**  
Smart Fix with slot 60 mm

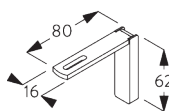

**SG 11207**  
Smart Fix with slot 80 mm

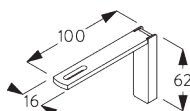

**SG 11208**  
Smart Fix with slot 100 mm

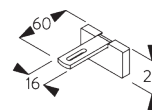

**SG 11216**  
Square Smart Fix with slot 60  
mm

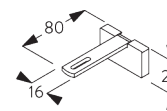

**SG 11217**  
Square Smart Fix with slot 80  
mm

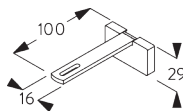

**SG 11218**  
Square Smart Fix with slot  
100 mm

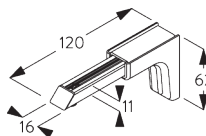

**SG 11154**  
Universal Smart Fix 120 mm

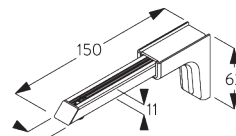

**SG 11155**  
Universal Smart Fix 150 mm

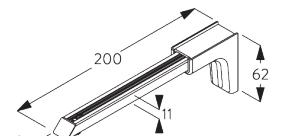

**SG 11156**  
Universal Smart Fix 200 mm

## D. WALL SUPPORT

### Bracket SG 6620

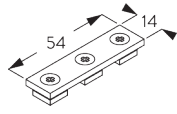
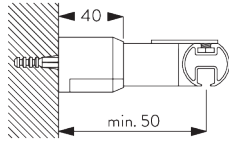

**SG 6123**  
Connection plate

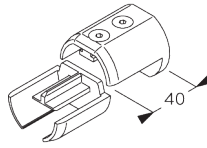

**SG 6620**  
Wall bracket

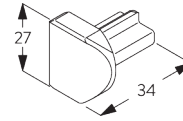

**SG 6631**  
Connection piece

## E. PROFILE JUNCTIONS

### Connection bridge SG 6521

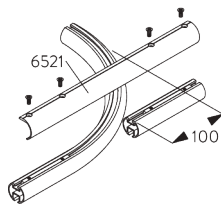
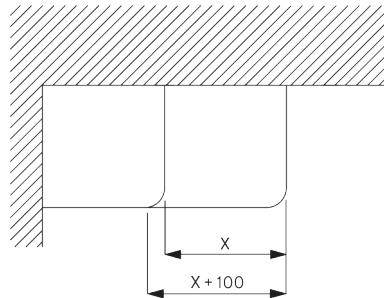

Note: be sure to attach a sketch!

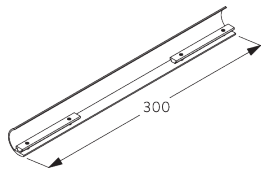

**SG 6521**  
Connection bridge

### Connection set SG 6635

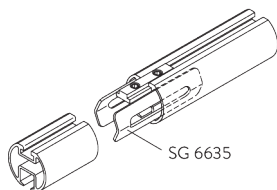

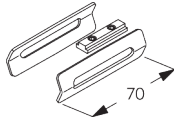

**SG 6635**

Connection bridge set

# SYSTEM OPTIONS

## A. LAYOUT OPTIONS

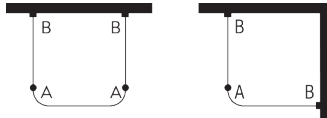

A: Hanger rod  
B: Wall support

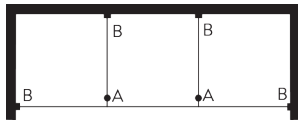

A: Hanger rod  
B: Wall support

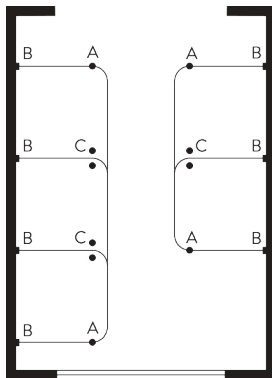

A: Hanger rod  
B: Wall support  
C: V-hanger

## B. WAVE

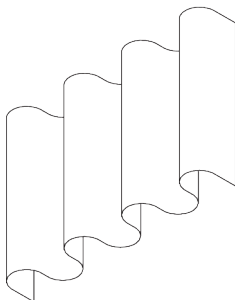



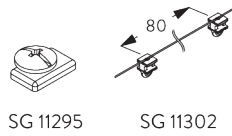

SG 11295

SG 11302

Standard components:

- SG 11295 End stop
- SG 11302 Wave 2C glider cord 80 mm

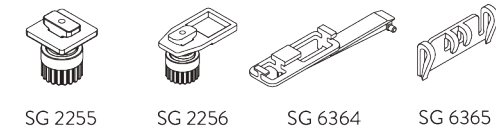

SG 2255

SG 2256

SG 6364

SG 6365

Optional components:

- SG 2255 Brake
- SG 2256 Brake
- SG 6364 Wave extension
- SG 6365 Wave hanger
- SG 6366 Wave carrier for draw rod
- SG 10430-34 Draw rod
- SG 11303 Wave 2C glider cord 60 mm



SG 6366

SG 10430-34

SG 11303

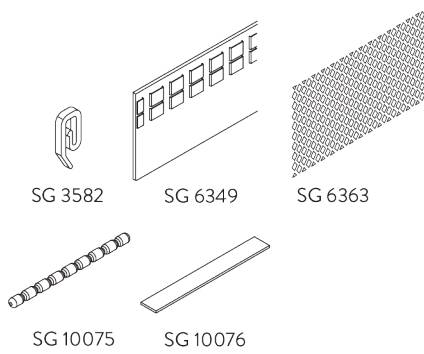

SG 3582

SG 6349

SG 6363

SG 10075

SG 10076

Curtain components:

- SG 3582 Hook
- SG 6349 Wave curtain tape
- SG 6363 Wave top hemming tape
- SG 10075 Lead weight 50 gr/m
- SG 10076 Fabric weight

Wave stack depth - 2C glider cord (standard components)

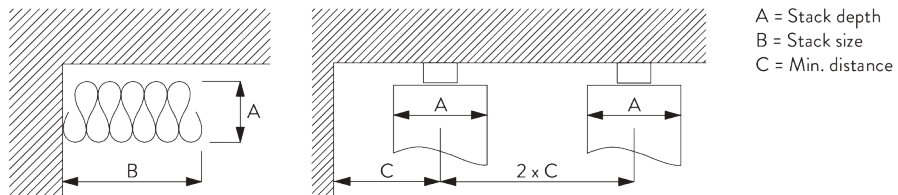

| 2C Glider cord<br>SG 11302 | Pockets between<br>hooks | Approx. curtain<br>fullness | Stack depth<br>A | Stack size<br>B*          | Min distance<br>C |
|----------------------------|--------------------------|-----------------------------|------------------|---------------------------|-------------------|
| 80                         | 6                        | ~2.1                        | 140              | 180 per metre<br>of track | 90                |
| 80                         | 7                        | ~2.3                        | 160              | 180 per metre<br>of track | 100               |

| 2C Glider cord<br>SG 11303 | Pockets between<br>hooks | Approx. curtain<br>fullness | Stack depth<br>A | Stack size<br>B*          | Min distance<br>C |
|----------------------------|--------------------------|-----------------------------|------------------|---------------------------|-------------------|
| 60                         | 4                        | ~2.1                        | 100              | 230 per metre<br>of track | 70                |
| 60                         | 5                        | ~2.3                        | 120              | 230 per metre<br>of track | 80                |

\*Stack size B when using optional extension arm increases by 150 mm per curtain stack!

# PARTS

## A. STANDARD PARTS

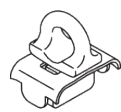

**SG 6065**  
End stop

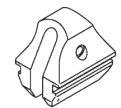

**SG 6086**  
Spring stop



**SG 6103p**  
Profile

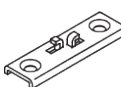

**SG 6124**  
Bracket

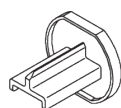

**SG 6630**  
End cover



**SG 11300**  
2C glider

## B. OPTIONAL PARTS

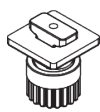

**SG 2255**  
Brake

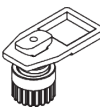

**SG 2256**  
Brake

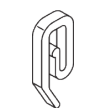

**SG 3582**  
Hook



**SG 6053**  
Spring stop



**SG 6094**  
Roller



**SG 6098**  
Roller



**SG 6110**  
Dust cover

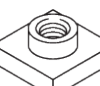

**SG 6117**  
Slot nut

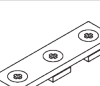

**SG 6123**  
Connection plate

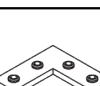

**SG 6125**  
Corner connection piece

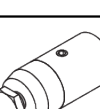

**SG 6175**  
Mini hanger



**SG 6190**  
Hanger

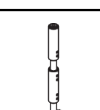

**SG 6196**  
Double hanger

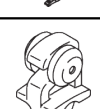

**SG 6283**  
Roller



**SG 6349**  
Wave curtain tape



**SG 6363**  
Wave top hemming tape

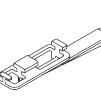

**SG 6364**  
Wave extension



**SG 6365**  
Wave hanger

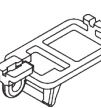

**SG 6366**  
Wave carrier for draw rod



**SG 6501**  
V-Hanger

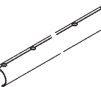

**SG 6521**  
Connection bridge



**SG 6530**  
V-Hanger

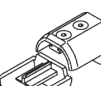

**SG 6620**  
Wall bracket

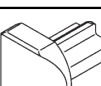

**SG 6631**  
Connection piece

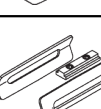

**SG 6635**  
Connection bridge set

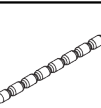

**SG 10075**  
Lead weight 50 g/m

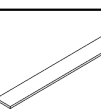

**SG 10076**  
Fabric weight

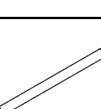

**SG 10430**  
Draw rod 50 cm

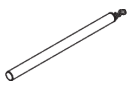

**SG 10431**

*Draw rod 75 cm*

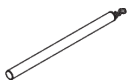

**SG 10432**

*Draw rod 100 cm*



**SG 10433**

*Draw rod 125 cm*

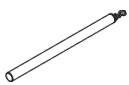

**SG 10434**

*Draw rod 150 cm*



**SG 10492**

*Pan head screw M4x8*

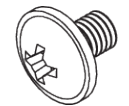

**SG 11131**

*Pan head screw with flange M4x6*

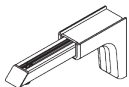

**SG 11154**

*Universal Smart Fix 120 mm*

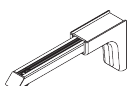

**SG 11155**

*Universal Smart Fix 150 mm*

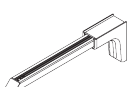

**SG 11156**

*Universal Smart Fix 200 mm*

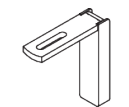

**SG 11206**

*Smart Fix with slot 60 mm*

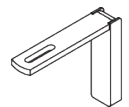

**SG 11207**

*Smart Fix with slot 80 mm*

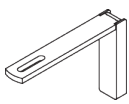

**SG 11208**

*Smart Fix with slot 100 mm*

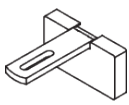

**SG 11216**

*Square Smart Fix with slot 60 mm*

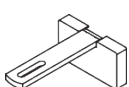

**SG 11217**

*Square Smart Fix with slot 80 mm*

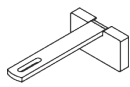

**SG 11218**

*Square Smart Fix with slot 100 mm*

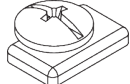

**SG 11295**

*End stop*



**SG 11301**

*2C glider on strip*

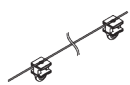

**SG 11302**

*Wave 2C glider cord 80 mm*

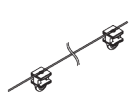

**SG 11303**

*Wave 2C glider cord 60 mm*

