

SG 5600

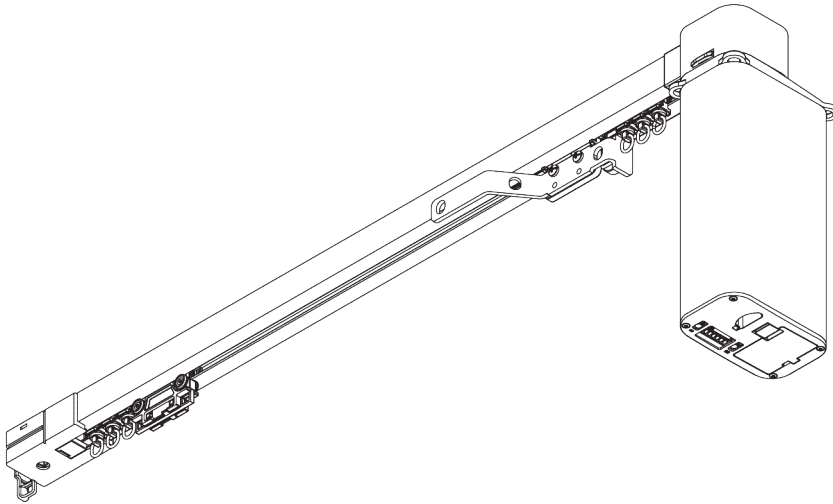
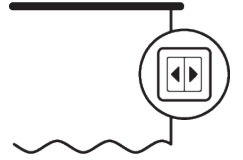

PRODUCT INFORMATION

- **Operation:** motorised
- **Range:** S - L
- **Fitting:** ceiling, wall, recess
- **Colours:** white RAL 9016, black RAL 9005 or anodised aluminum, special colours possible (recess profile only in white RAL 9016, black RAL 9005 or special color)
- **Fabrics:** refer to Silent Gliss fabric collection

Features:

- Quiet, fast and powerful motor
- 2-component (2C) roller technology
- Wave (2C)
- Various control options
- Touch & Go
- Manual override incl. permanent positioning sensor
- Easy programming
- 100-250 AC and / or 24 V DC in one motor
- Bendable
- Bendable recess profile

SYSTEM SPECIFICATIONS

A. SYSTEM DIMENSIONS



25 m

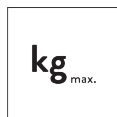

65 kg

Max. curtain weights with 2C rollers / Wave rollers

Up to 12 m: Touch & Go, manual override, auto programming mode

	2 m	4 m	6 m	8 m	10 m	12 m	15 m	18 m	21 m	25 m
	25	45	45	50	65	45	45	45	45	40
	25	45	45	50	65	45	45	45	45	40
	25	35	35	40	35	35	35	32	29	25
	25	35	35	40	35	35	35	32	29	25
	25	30	30	30	25	25	22	19	15	-
	25	30	30	30	25	25	22	19	15	-
	20	20	20	18	16	12	10	-	-	-
	20	20	20	18	16	12	10	-	-	-

(kg max.)

Max. curtain weights with Wave gliders

	2 m	4 m	6 m	8 m	10 m
	20	25	25	25	20
	20	25	25	25	20
	20	20	20	20	15
	20	20	20	20	15
	20	20	20	15	10
	20	20	20	15	10
	20	20	15	8	-
	20	20	15	8	-

(kg max.)

B. PROFILE

Profile and bending information

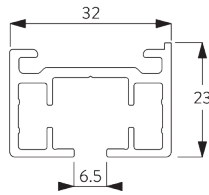

SG 10850

Profile

Radius:
✓ >25 cm

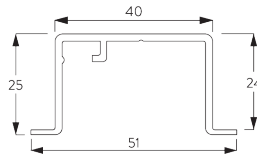

SG 10862

Recess profile

Radius:
✓ 50 - 75 cm
>75 cm on request

C. HOW TO MEASURE

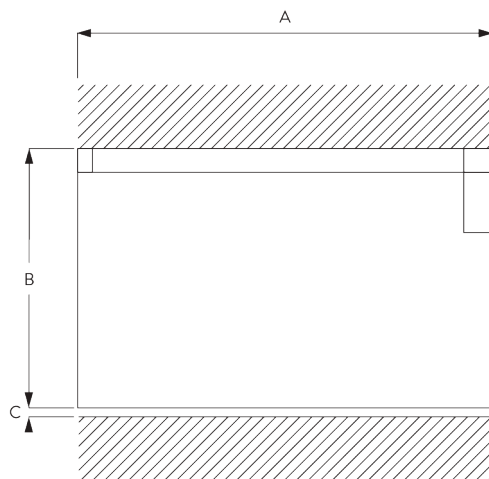

A: System width
B: System height
C: Distance between floor and fabric

D. SPECIFICATION

TEXT

EN

Silent Gliss 5600 Electrically Operated Curtain Track with motor. Comprises aluminium profile SG 10850 in silver anodized / white powder coated finish alternatively a specified RAL colour. Complete and ready assembled with interference free brushless motor SG. Supplied with 2C roller gliders SG 10840. Features manual 'Touch and Go' operation and manual override in the event of power failure. Top fixed with clamps SG 3004/3041 at max. 500 mm centres / face fixed with Silent Gliss Smart Fix. Optional recess profile SG 10862. Controlled through wall switch/wireless switch or a Smart house solution. Can be used with system Wave.

SV

Silent Gliss SG 5600 eldragssystem med motor. Består av aluminiumprofil SG 10850 i specificerad längd i vitlack, alu natur eller angiven RAL färg komplett med borstlös och störningsfri motor SG 9060 monterad. 10 st SG 10840 2C rullglid per meter. Ingår inställningsmöjlighet "Touch and Go" med manuell start och säkerhetsfunktion vid strömavbrott. Takmonteras med fäste SG 3004/3041 c/c 500 mm. Vägghäring med SG Smart Fix c/c 500 mm. Kan levereras med infällningsprofil SG 10862. Styning med väggkontakt/trådlös sändare/inkoppling mot Smarthus system. Kan användas med system Wave.

NO

Silent Gliss SG 5600 Elektrisk gardinskinne. Består av aluminiumprofil SG 10850 i spesifisert lengde, standard i hvitlakkert eller alu natur. Kan også leveres i spesifisert RAL farge. Børsteløs og lydløs motor SG 9060. 10 stk SG 10840 2C rulleglidere pr meter. Funksjonen «touch and go» er en manuell sikkerhetsfunksjon ved strømstans. Takmonteres med feste SG 10926 c/c 500 mm. Veggmontering med SG Smart Fix c/c 500 mm. Kan leveres med profil for innfelling SG 10862. Styning med veggkontakt/ trådløs sender /innkobling mot Smarthus system. Kan kombineres med Wave system.

DA

Silent Gliss 5600 elektrisk gardinskinnesystem med motor. Består af en aluminiumprofil SG 10850, sølvanodiseret eller hvid pulverlakering, alternativt en specificeret RAL-farve. Fuldstændig klart og samlet med interferensfri børsteløs motor SG. Leveres med 2C rulleglidere SG 10840. Har en manuel "Touch and Go" funktion med håndbetjening ved strømafbrydelser. Loftmonteres med klemmerne SG 3004/3041 med en afstand på højst 500 mm eller vægghæring med Silent Gliss Smart Fix. Kan leveres med indfældningsprofil SG 10862. Styes med en vægkontakt, trådløs kontakt eller en Smart house-løsning. Kan bruges med system Wave.

FITTING

A. FITTING INFORMATION

Fixing points

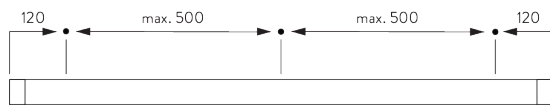

For detailed fitting information, visit the [Silent Gliss website](#).

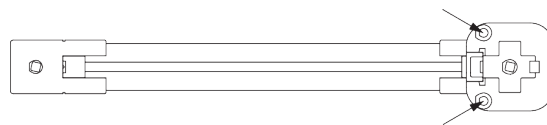

Motor holder to be fixed (ceiling fitting only).

B. CEILING FITTING

Clamp SG 3004

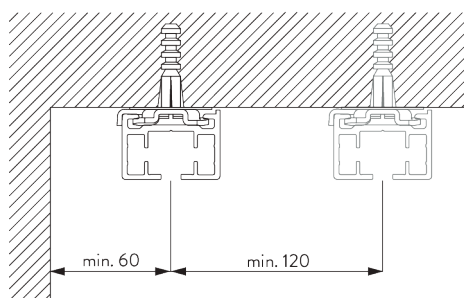

SG 3004
Clamp

Direct fitting (2C roller only)

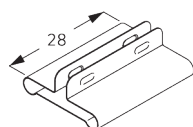
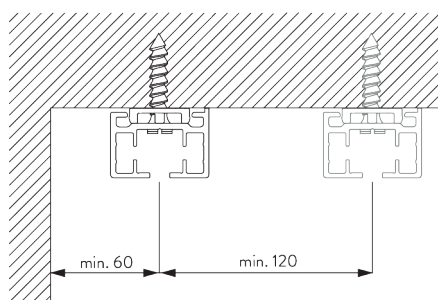

SG 7002
Profile protector

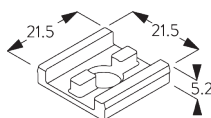

SG 10865
Support plate

C. WALL FITTING

Smart Fix

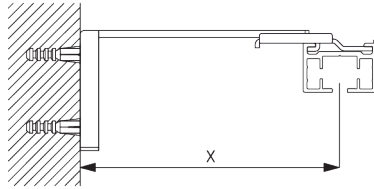

Smart Fix SG 11200 - SG 11205 and bracket SG 3041:
Screw SG 10492 (M4x8) needed.

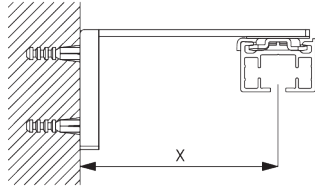

Smart Fix SG 11200 - SG 11205 and clamp SG 3004:
Screw SG 10074 (M4x8) needed.

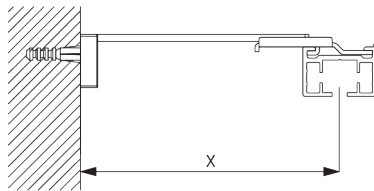

Square Smart Fix SG 11210 - SG 11215 and bracket SG 3041:
Screw SG 10492 (M4x8) needed.

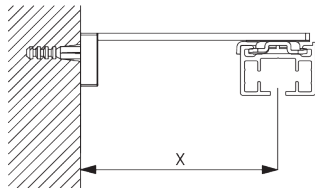

Square Smart Fix SG 11210 - SG 11215 and clamp SG 3004:
Screw SG 10074 (M4x8) needed.

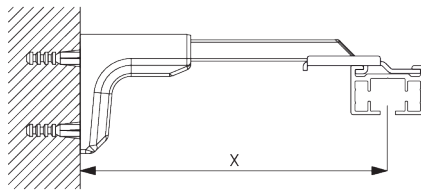

Universal Smart Fix SG 11154 - SG 11156 and bracket SG 3041:
Screw SG 10407 (M4x10) needed.

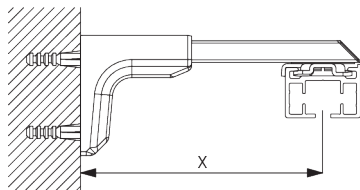

Universal Smart Fix SG 11154 - SG 11156 and clamp SG 3004:
Screw SG 11158 (M4x12) needed.

Smart Fix	X mm (SG 3041)	X mm (SG 3004)
SG 11200 / SG 11210	83	
SG 11201 / SG 11211	103	72
SG 11202 / SG 11212	123	92
SG 11203 / SG 11213	143	112
SG 11204 / SG 11214	173	142
SG 11205 / SG 11215	223	192
SG 11154	128-156	102-130
SG 11155	158-186	132-160
SG 11156	208-236	182-210

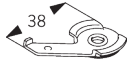

SG 3004
Clamp

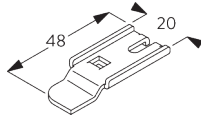

SG 3041
Bracket



SG 10074
Countersunk head screw
M4x8



SG 10407
Pan head screw M4x10



SG 10492
Pan head screw M4x8



SG 11158
Countersunk head screw
M4x12

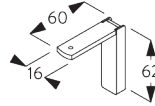

SG 11200
Smart Fix 60 mm

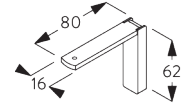

SG 11201
Smart Fix 80 mm

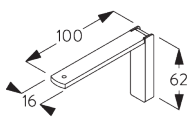

SG 11202
Smart Fix 100 mm

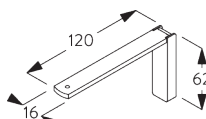

SG 11203
Smart Fix 120 mm

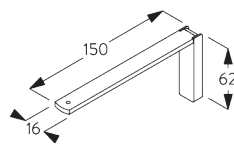

SG 11204
Smart Fix 150 mm

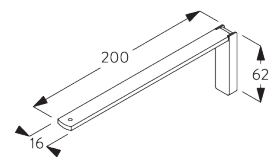

SG 11205
Smart Fix 200 mm

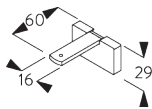

SG 11210
Square Smart Fix 60 mm

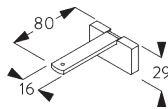

SG 11211
Square Smart Fix 80 mm

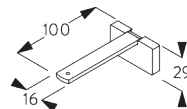

SG 11212
Square Smart Fix 100 mm

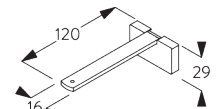

SG 11213
Square Smart Fix 120 mm

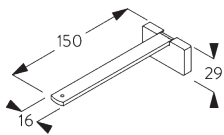

SG 11214
Square Smart Fix 150 mm

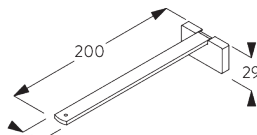

SG 11215
Square Smart Fix 200 mm

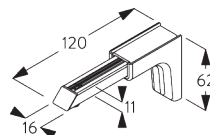

SG 11154
Universal Smart Fix 120 mm

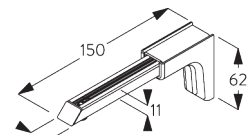

SG 11155
Universal Smart Fix 150 mm

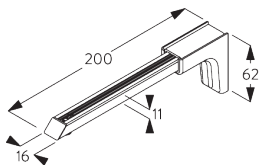

SG 11156
Universal Smart Fix 200 mm

D. RECESS FITTING

Recess profile SG 10862

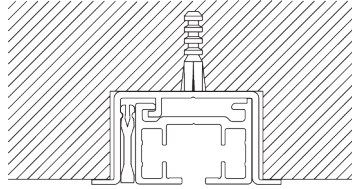

One wedge SG 5118 per fixing point.
For detailed recess fitting, visit the Silent Gliss website.

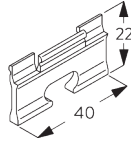

SG 5118
Wedge

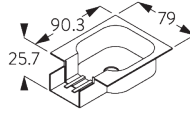

SG 10863
Recess mask

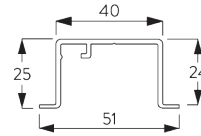

SG 10862
Recess profile

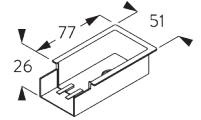

SG 10864
Recess mask

Motor recessed in suspended ceiling

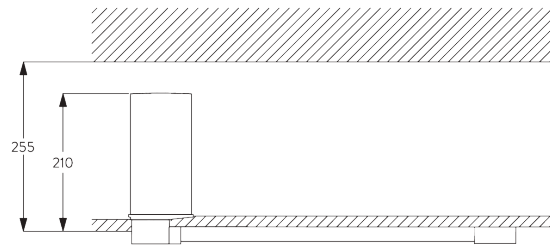

Profile mounted with clamp SG 3004.

Access to the ceiling space is necessary for assembly / programming.

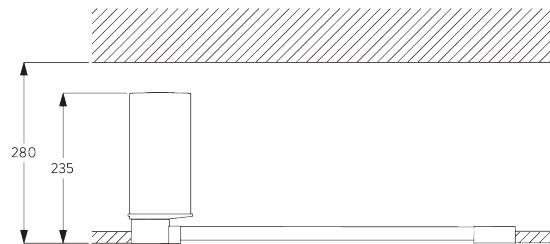

Profile SG 10862 recessed into ceiling.

Access to the ceiling space is necessary for assembly / programming.

**E. SUSPENDED
FITTING**

Hanger SG 6105

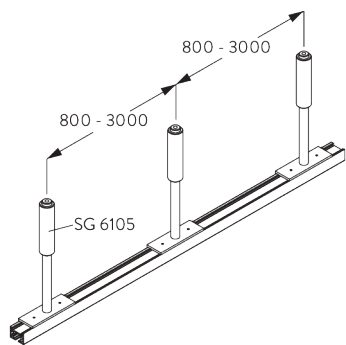

Curtain weight reduces by 30%.

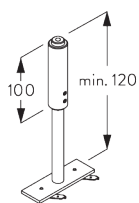

SG 6105

Hanger with plate

V-hanger SG 6107

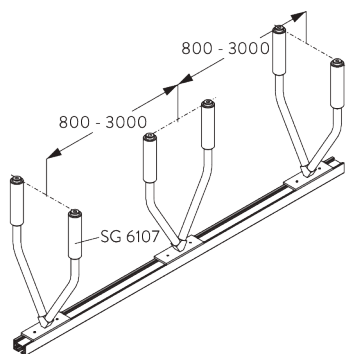

Curtain weight reduces by 30%.

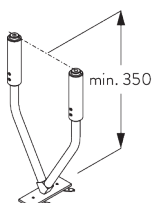

SG 6107

V-Hanger with plate

SYSTEM OPTIONS

A. WAVE

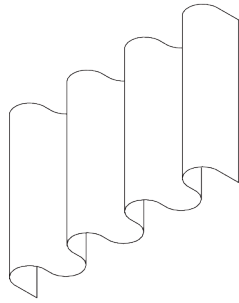

SG 6365



SG 10844

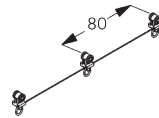

SG 10852



SG 10854



SG 10856



SG 10867



SG 10886



SG 10887

Standard components:

- SG 6365 Wave hanger
- SG 10844 Wave end stop
- SG 10852 Wave 2C roller cord, 80 mm
- SG 10854 Wave overlap arm support
- SG 10856 Wave end stop, belt return
- SG 10867 Panhead screw
- SG 10886 Wave extension
- SG 10887 Wave overlap arm set

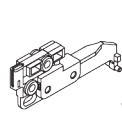

SG 10845

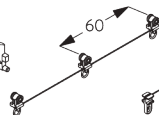

SG 10869

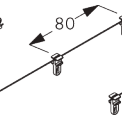

SG 10905

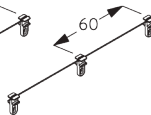

SG 10906

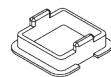

SG 10924

Optional components:

- SG 10845 Wave master carrier single stack 80 mm
- SG 10869 Wave 2C roller cord, 60 mm (no single stack)
- SG 10905 Wave glider cord, 80 mm
- SG 10906 Wave glider cord, 60 mm (no single stack)
- SG 10924 Wave glider support



SG 3582

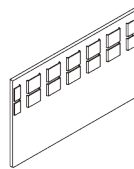

SG 6349

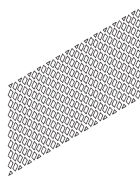

SG 6363

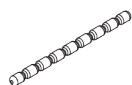

SG 10075



SG 10076

Curtain components:

- SG 3582 Hook
- SG 6349 Wave curtain tape
- SG 6363 Wave top hemming tape
- SG 10075 Lead weight 50 gr/m
- SG 10076 Fabric weight

Wave stack depth - 2C roller / glider cord (standard components)

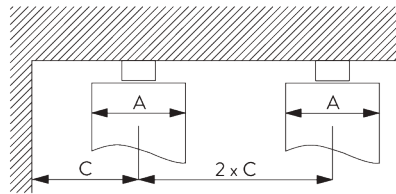
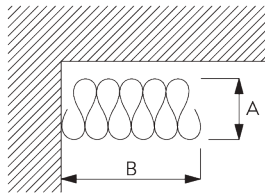

A = Stack depth
B = Stack size
C = Min. distance

Roller / glider cord SG 10852 / 10905	Pockets between hooks	Approx. curtain fullness	Stack depth A	Stack size B*	Min distance C
80	6	~2.1	140	210 per metre of track	90
80	7	~2.3	160	210 per metre of track	100

Roller / glider cord SG 10869 / 10906	Pockets between hooks	Approx. curtain fullness	Stack depth A	Stack size B*	Min distance C
60	4	~2.1	100	260 per metre of track	70
60	5	~2.3	120	260 per metre of track	80

*Stack size B plus 190 mm for each curtain stack!

MOTOR & CONTROLS

A. MOTOR FEATURES

Motor	SG 9060
-------	---------

Motor Features

Soft start / stop	●
Touch & Go	●
Manual Override	●
Modular radio system (optional)	●
Electronic end-stop	●
Electronic revolution counter (unlimited revolution)	●
Two intermediate positions possible	●
Parallel wiring possible without additional relays	●
High-end DC motor with brushless technology	●
Permanent positioning sensor (even without power)	●
100 - 250 V AC and / or 24 V DC in one motor	●
Cable connectable with plug into motor	●
IP class	IP 40

Control Features

Mains power control	●
Dry contact control	●
Dry contact and / or SG Control L (with radio module)	●
SG Control L (with radio module)	●
Smart by Silent Gliss (with smart module)	●
Suitable for all common home automation systems (with suitable interface)	●

B. MOTOR SPECIFICATIONS

Motor	Motor dimensions	Voltage AC	Voltage DC	Current	Frequency	System speed / sec	Frequency receiver
SG 9060	L 206 x W 60 x D 96	100 - 250 V AC	24 V DC	1.3 - 0.5 A	50 - 60 Hz	21 cm / sec	-
SG 9060 w/ SG Control L	L 226 x W 60 x D 96	100 - 250 V AC	24 V DC	1.3 - 0.5 A	50 - 60 Hz	21 cm / sec	868/915 MHz
SG 9060 w/ Smart by SG	L 226 x W 60 x D 96	100 - 250 V AC	24 V DC	1.3 - 0.5 A	50 - 60 Hz	21 cm / sec	Smart by SG

C. MOTOR DIMENSIONS / MODULES

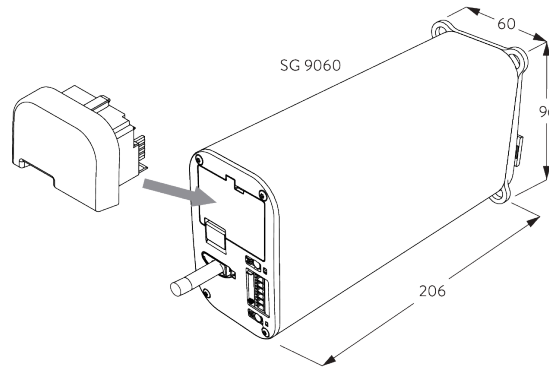

Motor SG 9060 can be equipped with following modules:

- SG 9063 Radio module SG Control L

See catalogue "controls" for details.

D. OPERATING METHODS

See catalogue "controls" for details.

Wall switch



System can be operated by fixed wall switch.

SG Control L



Various radio hand-held and wall transmitters available.



Silent Gliss Move App.

Smart by Silent Gliss



Open designed two-way communication system which allows to flawlessly integrate products with most major building management systems. Smart module SG 11270 required.

E. WIRING DIAGRAMS



Refer to Silent Gliss website.

PARTS

A. STANDARD PARTS

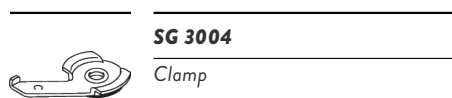

SG 3004

Clamp

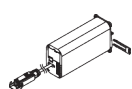

SG 9060

Motor 100-250V AC & 24V DC

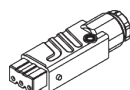

SG 9917

Hirschmann portable socket-outlet STAK 3 N

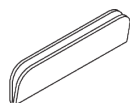

SG 10725

Programming distance holder

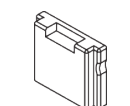

SG 10815

Cover

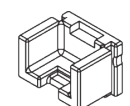

SG 10816

Cover

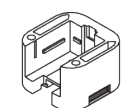

SG 10817

Motor holder

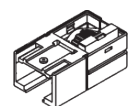

SG 10819

Belt return

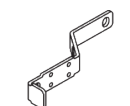

SG 10821

Overlap arm

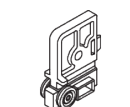

SG 10822

Master carrier

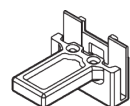

SG 10823

Belt connector arm

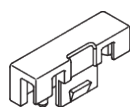

SG 10824

Belt connector pin



SG 10825

Belt

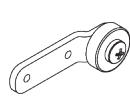

SG 10826

Overlap arm support

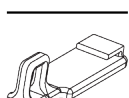

SG 10836

Mask pair stack

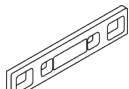

SG 10837

Pilot runner



SG 10838

Pilot runner



SG 10840

2C roller

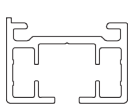

SG 10850

Profile

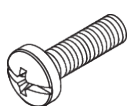

SG 10923

Pan head screw Freedriv M4x12

B. OPTIONAL PARTS

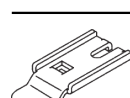

SG 3041

Bracket

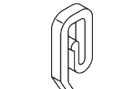

SG 3582

Hook

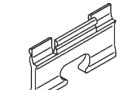

SG 5118

Wedge

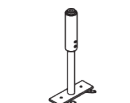

SG 6105

Hanger with plate



SG 6107

V-Hanger with plate



SG 6349

Wave curtain tape

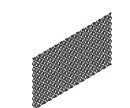

SG 6363

Wave top hemming tape

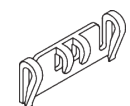

SG 6365

Wave hanger

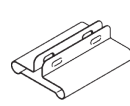

SG 7002

Profile protector

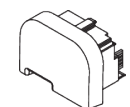

SG 9063

Radio module type L

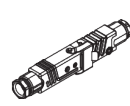

SG 9916

Hirschmann plug set

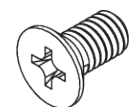

SG 10074

Countersunk head screw M4x8







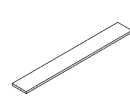





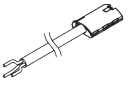
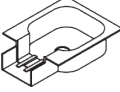
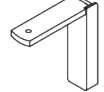
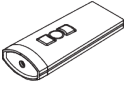
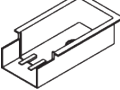
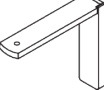

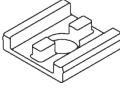
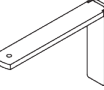
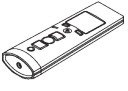
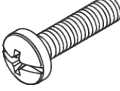
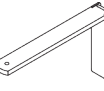
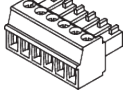

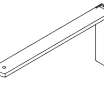
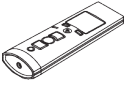
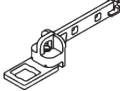
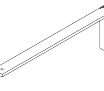
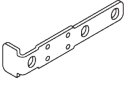
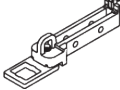
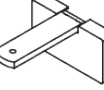
SG 10075

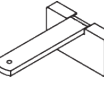
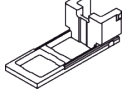
Lead weight 50 g/m

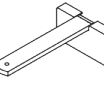
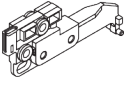
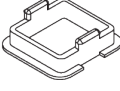
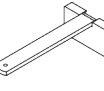

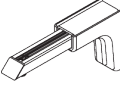
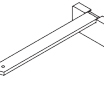
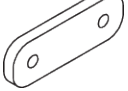
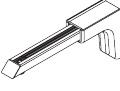
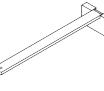
SG 10076

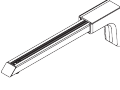
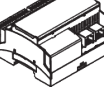
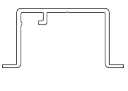
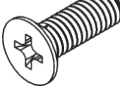
Fabric weight

	SG 10293 Cable 230V AC, 2/3/5/10 m		SG 10863 Recess mask		SG 11200 Smart Fix 60 mm
	SG 10300 Radio hand held 1 channel		SG 10864 Recess mask		SG 11201 Smart Fix 80 mm
	SG 10302 Radio hand held 5+1 channel		SG 10865 Support plate		SG 11202 Smart Fix 100 mm
	SG 10303 Radio hand held 10+2+1 channel		SG 10867 Pan head screw Freedriv M4x16		SG 11203 Smart Fix 120 mm
	SG 10714 Plug 6-pin, MC 1.5/6-ST-3.81		SG 10869 Wave 2C roller cord 60 mm		SG 11204 Smart Fix 150 mm
	SG 10804 Radio hand held 15+5+1 channel		SG 10886 Wave extension		SG 11205 Smart Fix 200 mm
	SG 10820 Overlap arm		SG 10887 Wave extension		SG 11210 Square Smart Fix 60 mm
	SG 10831 Connection bridge		SG 10905 Wave glider cord 80 mm		SG 11211 Square Smart Fix 80 mm
	SG 10844 Wave end stop		SG 10906 Wave glider cord 60 mm		SG 11212 Square Smart Fix 100 mm
	SG 10845 Wave master carrier 80 mm		SG 10924 Wave glider support		SG 11213 Square Smart Fix 120 mm
	SG 10852 Wave 2C roller cord 80 mm		SG 11154 Universal Smart Fix 120 mm		SG 11214 Square Smart Fix 150 mm
	SG 10854 Wave overlap plate		SG 11155 Universal Smart Fix 150 mm		SG 11215 Square Smart Fix 200 mm
	SG 10856 Wave extension		SG 11156 Universal Smart Fix 200 mm		SG 11260 Gateway Cedia
	SG 10862 Recess profile		SG 11158 Countersunk head screw M4x12		SG 11261 Gateway KNX

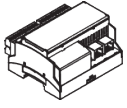

SG 11262

Expansion unit

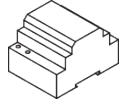

SG 11264

Power supply 24V DC, 3.8 Ampere
DIN Rail

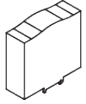

SG 11265

Power supply 24V DC, 5 Ampere
DIN Rail

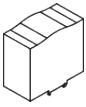

SG 11266

Power supply 24V DC, 10 Ampere
DIN Rail

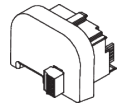

SG 11270

Smart module

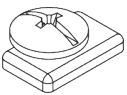

SG 11295

End stop

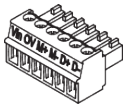

SG 11325

Smart plug 6-pin, MC 1.5/6 ST-3.81



SG 11480

Radio wall transmitter 1 channel



SG 11490

Radio wall transmitter 5+1 channel
