

SG 1012

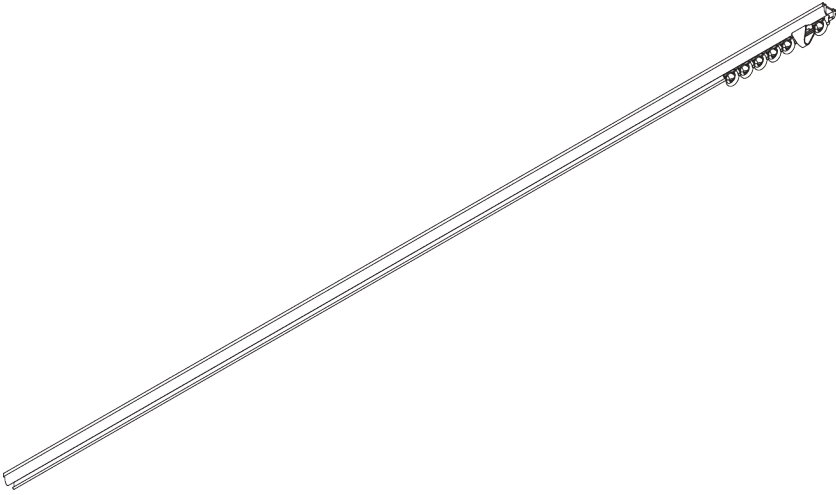

PRODUCT INFORMATION

- **Operation:** hand
- **Range:** S
- **Fitting:** recess (center SG 7550)
- **Colours:** white RAL 9016 or anodised aluminum, special colours possible
- **Fabrics:** refer to Silent Gliss fabric collection

Features:

- Pre-drilled profile
- Bendable

SYSTEM SPECIFICATIONS

A. PROFILE

Profile and bending information

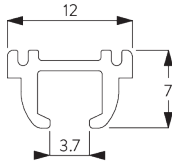

SG 1012p

Profile

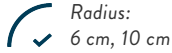

B. HOW TO MEASURE

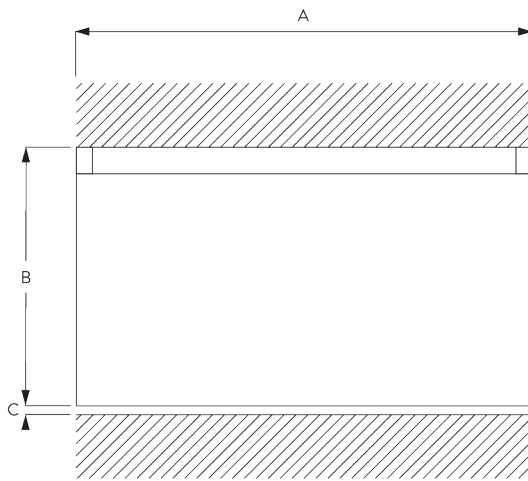

A: System width

B: System height

C: Distance between floor and fabric

C. SPECIFICATION

TEXT

EN

Silent Gliss SG 1012 Hand Drawn Curtain Track System. Comprises aluminium profile SG 1012 supplied made to measure in silver anodised or white powder coated, alternatively a specified RAL colour. SG 3533 at 14/m and 2 end covers SG 3512/ end stops SG 3070/SG 3085 Spring stops per length. Top fixed with brackets SG 3112/3121 at max. 120 mm centres. Or directly to ceiling with screws SG 3019/3025.

SV

Silent Gliss SG 1012 handdragssystem. Består av aluminiumprofil SG 1012 i specificerad längd i vitlack, alu natur eller angiven RAL färg. 14 st SG 3533 glid per meter, 2 st SG 3512 ändskydd samt 2 st SG 3070 vridstopp/SG 3085 fjäder per system. Takmonteras med fäste SG 3112/3121 c/c 120 mm. Alternativt skruvas direkt i tak m skruv SG 3019/SG 3025.

NO

Silent Gliss SG 1012 manuell gardinskinne. Består av aluminiumprofil SG 1012 i spesifisert lengde, standard i hvitlakkert eller alu natur. Kan også leveres i spesifisert RAL farge. 14 stk SG 3533 glidere pr meter, 2 stk SG 3070 vridstopp/SG 3085 fjær pr system. Takmonteres med feste SG3112/3121 c/c 120 mm. Alternativt skrues skinnen direkte i taket med skruer SG 3019/SG 3025.

DA

Silent Gliss SG 1012 håndtrukket gardinskinnesystem. Består af en aluminiumprofil SG 1012 i ønsket længde, sølvanodiseret eller hvid pulverlakering, alternativt en specificeret RAL-farve. 14 stk. SG 3533 pr. m og 2 stk. SG 3512 endelåg eller SG 3070/SG 3085 fjeder pr. længde. Loftmonteres med beslagene SG 3112/3121 med højst 120 mm afstand. Eller direkte i loftet med skruer SG3019/3025.

FITTING

A. FITTING INFORMATION

For detailed fitting information, visit the Silent Gliss website.

Fixing points

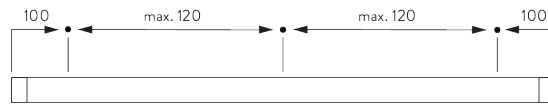

Profile Protector

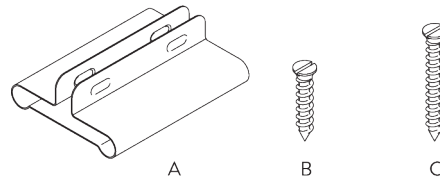

A: Profile Protector SG 7002
 B: Special Screw SG 3019 / 12 mm
 C: Special Screw SG 3025 / 18 mm

B. CEILING FITTING

Direct into wood

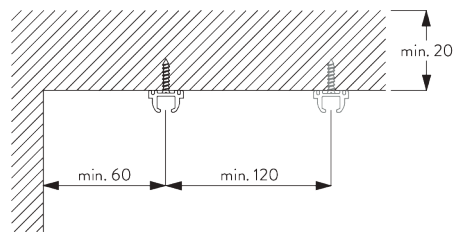

Bracket SG 3112

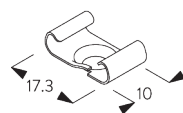
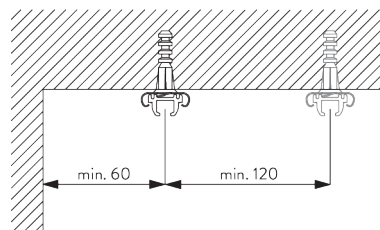

SG 3112
 Bracket



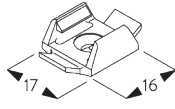
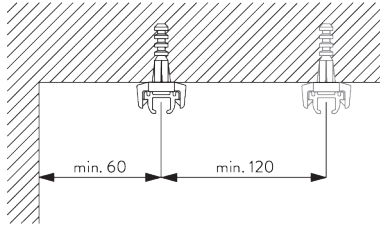

Bracket SG 3121





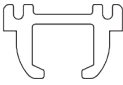
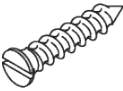











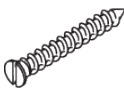

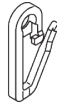
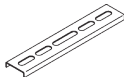

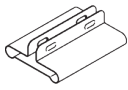
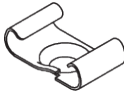
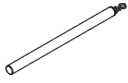
SG 3121
Bracket

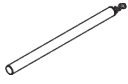
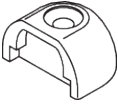
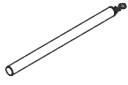
PARTS

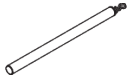
A. STANDARD PARTS

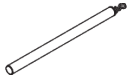
	SG 1012p Profile
	SG 3019 Special screw 12 mm
	SG 3070 End stop
	SG 3085 Spring stop
	SG 3533 Glider

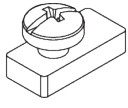
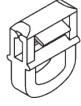
B. OPTIONAL PARTS

	SG 3016 End stop		SG 3570 Glider
	SG 3020 Hook		SG 3571 Hook
	SG 3025 Special screw 18 mm		SG 3582 Hook
	SG 3032 Spring stop		SG 3598 Eyelet
	SG 3064 Connecting bridge		SG 3599 Hook
	SG 3071 End stop		SG 7002 Profile protector
	SG 3112 Bracket		SG 10430 Draw rod 50 cm
	SG 3511 Glider		SG 10431 Draw rod 75 cm
	SG 3512 End cover		SG 10432 Draw rod 100 cm
	SG 3534 Glider 3533 on strip		SG 10433 Draw rod 125 cm
	SG 3535 Glider		SG 10434 Draw rod 150 cm
	SG 3537 Glider		SG 11335 End stop
	SG 3548 Glider		
	SG 3549 Click glider with hook		

