

# SG 1015

---

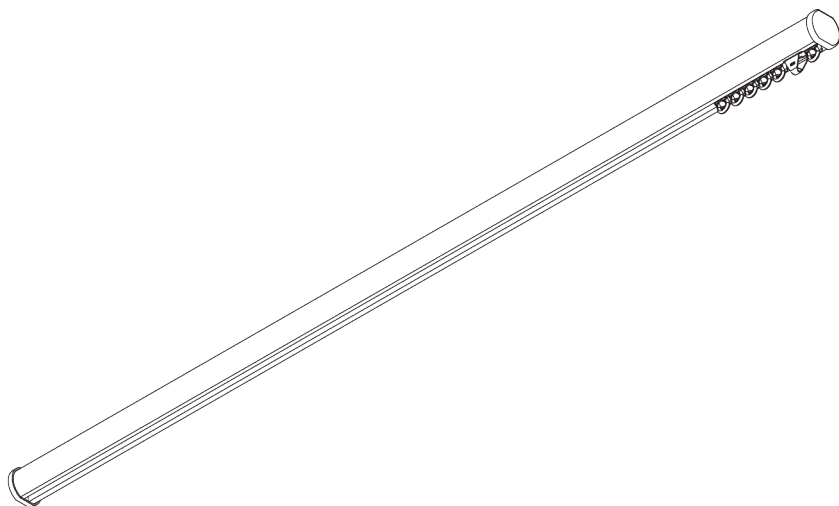
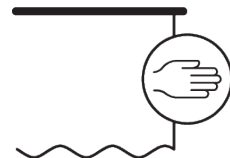

## PRODUCT INFORMATION

- **Operation:** hand
- **Range:** S
- **Fitting:** ceiling, wall
- **Colours:** white RAL 9016 or anodised aluminum, special colours possible
- **Fabrics:** refer to Silent Gliss fabric collection

### **Features:**

- Bendable

# SYSTEM SPECIFICATIONS

## A. PROFILE

Profile and bending information

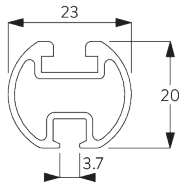

**SG 1003p**

Profile

✓ Radius:  
15 cm, 20 cm, >25 cm

## B. HOW TO MEASURE

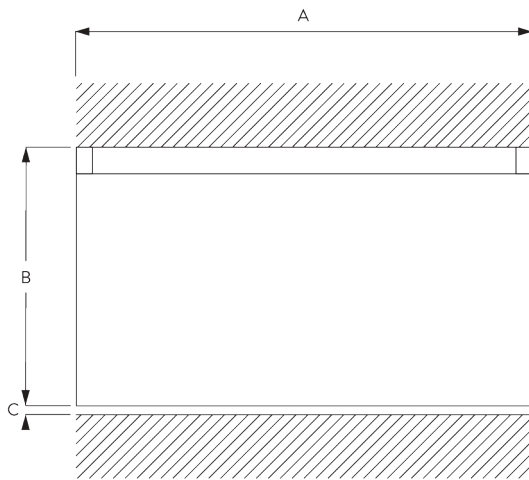

A: System width

B: System height

C: Distance between floor and fabric

## C. SPECIFICATION TEXT

### EN

Silent Gliss SG 1015 Hand Drawn Curtain Track System. Comprises aluminium profile SG 1003 supplied made to measure in silver anodised or white powder coated, alternatively a specified RAL colour. SG 3533 at 14/m and 2 end covers SG 3014/ end stops SG 3070 per length. Top fixed with brackets SG 6175 at max. 800 mm centres / wall fix SG Smart Fix at max. 800 mm centres.

### SV

Silent Gliss SG 1015 handdragssystem. Består av aluminiumprofil SG 1003 i specificerad längd i vitlack, alu natur eller angiven RAL färg. 14 st SG 3533 glid per meter, 2 st SG 3014 ändskydd samt 2 st SG 3070 vridstopp per system. Takmonteras med fäste SG 6124 /SG 6175 c/c 800 mm. Vägghmontering med Smart Fix c/c 800 mm.

### NO

Silent Gliss SG 1015 manuell gardinskinne. Består av aluminiumprofil SG 1003 i spesifisert lengde, standard hvitlakkert eller alu natur. Kan også leveres i spesifisert RAL farge. 14 stk SG 3533 glidere pr meter, 2 stk SG 3070 vrilstopp pr system. Takmonteres med feste SG 6175 c/c 800 mm. Veggmontering med Smart Fix c/c 800mm.

### DA

Silent Gliss SG 1015 håndtrukket gardinskinnesystem. Består af en aluminiumprofil SG 1003 i ønsket længde, sølvanodiseret eller hvid pulverlakering, alternativt en specificeret RAL-farve. 14 stk. SG 3533 glidere pr. m og 2 stk. endelåg SG 3014 samt 2 stk. SG 3070 endestop pr. længde. Loftmonteres med beslagene SG 6175 med højst 800 mmafstand. Vægmonteres med SG Smart Fix med højst 800 mm afstand.

# FITTING

## A. FITTING INFORMATION

### Fixing points

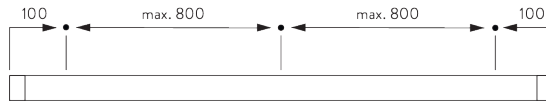

For detailed fitting information, visit the Silent Gliss website.

## B. CEILING FITTING

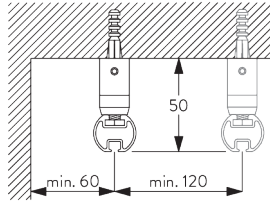

Mini hanger SG 6175

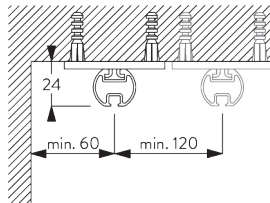

Bracket SG 6124

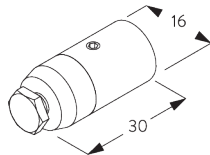

SG 6175  
Mini hanger

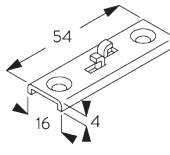

SG 6124  
Bracket

## C. WALL FITTING

### Smart Fix

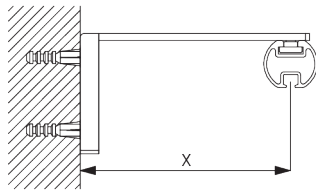

**Smart Fix with slot SG 11206 - SG 11208:**  
Screw SG 10492 (M4x8) needed.

Smart Fix	X mm
SG 11206 / SG 11216	33-51
SG 11207 / SG 11217	53-71
SG 11208 / SG 11218	73-91
SG 11154	102-130
SG 11155	132-160
SG 11156	182-210

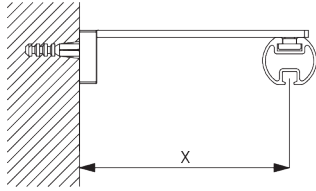

**Square Smart Fix with slot SG 11216 - SG 11218:**

Screw SG 10492 (M4x8) needed.

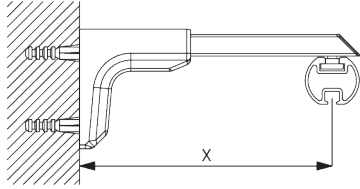

**Universal Smart Fix SG 11154 - SG 11156:**

Screw SG 11131 (M4x6) needed.

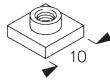

**SG 6117**

Slot nut



**SG 10492**

Pan head screw M4x8



**SG 11131**

Pan head screw with flange M4x6

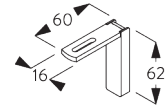

**SG 11206**

Smart Fix with slot 60 mm

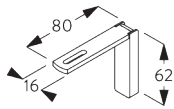

**SG 11207**

Smart Fix with slot 80 mm

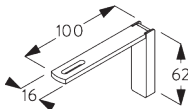

**SG 11208**

Smart Fix with slot 100 mm

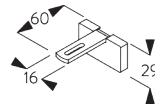

**SG 11216**

Square Smart Fix with slot 60 mm

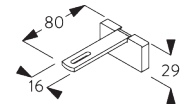

**SG 11217**

Square Smart Fix with slot 80 mm

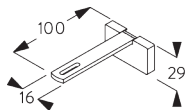

**SG 11218**

Square Smart Fix with slot 100 mm

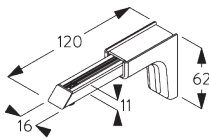

**SG 11154**

Universal Smart Fix 120 mm

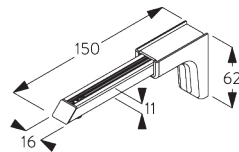

**SG 11155**

Universal Smart Fix 150 mm

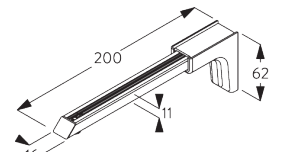





**SG 11156**



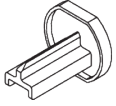

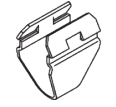

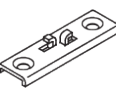

Universal Smart Fix 200 mm

# PARTS

## A. STANDARD PARTS

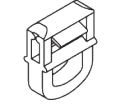
	<b>SG 1003p</b> Profile
	<b>SG 3014</b> End cover
	<b>SG 3070</b> End stop
	<b>SG 3085</b> Spring stop
	<b>SG 3533</b> Glider
	<b>SG 3599</b> Hook
	<b>SG 6124</b> Bracket

## B. OPTIONAL PARTS

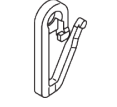
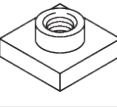
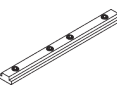
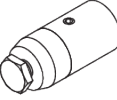
	<b>SG 3012</b> Hook
	<b>SG 3511</b> Glider
	<b>SG 3534</b> Glider 3533 on strip
	<b>SG 3535</b> Glider
	<b>SG 3537</b> Glider
	<b>SG 3548</b> Glider
	<b>SG 3549</b> Click glider with hook
	<b>SG 3570</b> Glider
	<b>SG 3581</b> Hook
	<b>SG 3582</b> Hook
	<b>SG 3598</b> Eyelet
	<b>SG 6117</b> Slot nut
	<b>SG 6173</b> Connection bridge
	<b>SG 6175</b> Mini hanger

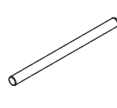
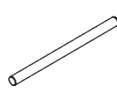
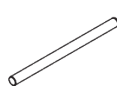
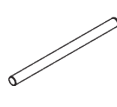
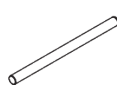
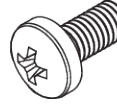
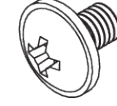
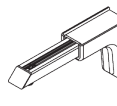
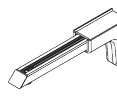
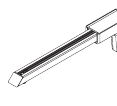
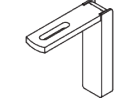
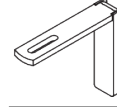
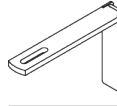
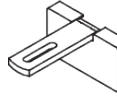
	<b>SG 10430</b> Draw rod 50 cm
	<b>SG 10431</b> Draw rod 75 cm
	<b>SG 10432</b> Draw rod 100 cm
	<b>SG 10433</b> Draw rod 125 cm
	<b>SG 10434</b> Draw rod 150 cm
	<b>SG 10492</b> Pan head screw M4x8
	<b>SG 11131</b> Pan head screw with flange M4x6
	<b>SG 11154</b> Universal Smart Fix 120 mm
	<b>SG 11155</b> Universal Smart Fix 150 mm
	<b>SG 11156</b> Universal Smart Fix 200 mm
	<b>SG 11206</b> Smart Fix with slot 60 mm
	<b>SG 11207</b> Smart Fix with slot 80 mm
	<b>SG 11208</b> Smart Fix with slot 100 mm
	<b>SG 11216</b> Square Smart Fix with slot 60 mm

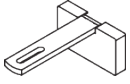

**SG 11217**

*Square Smart Fix with slot 80 mm*

---

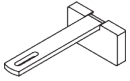

**SG 11218**

*Square Smart Fix with slot 100 mm*

---

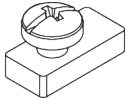

**SG 11335**

*End stop*

---



