

SG 6035

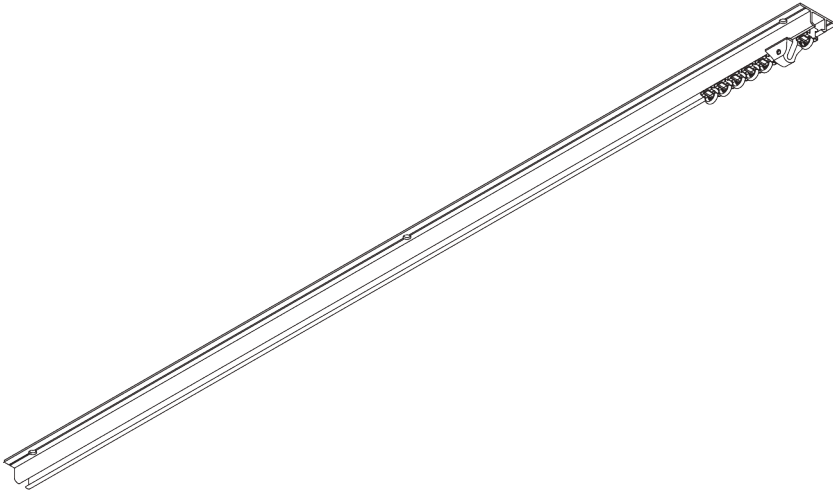

PRODUCT INFORMATION

- **Operation:** hand
- **Range:** M - L
- **Fitting:** ceiling
- **Colours:** white RAL 9016 or anodised aluminum, special colours possible
- **Fabrics:** refer to Silent Gliss fabric collection

Features:

- 2-component (2C) glider technology
- Wave (2C)
- Bendable
- Pre-drilled profile

SYSTEM SPECIFICATIONS

A. PROFILE

Profile and bending information

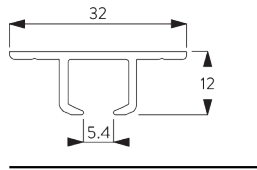

SG 6035p

Profile

Radius: >25 cm

B. HOW TO MEASURE

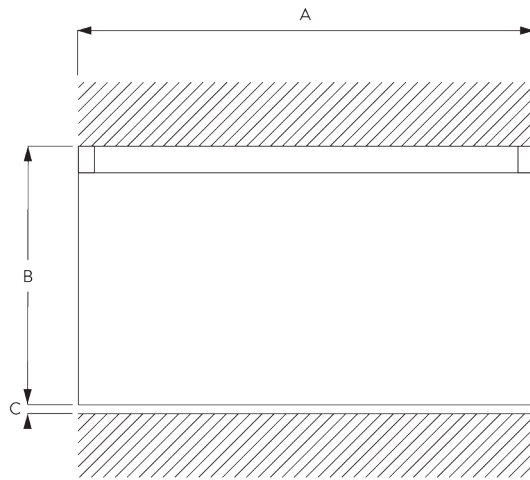

A: System width

B: System height

C: Distance between floor and fabric

FITTING

A. FITTING INFORMATION

Fixing points

For detailed fitting information, visit the [Silent Gliss website](#).

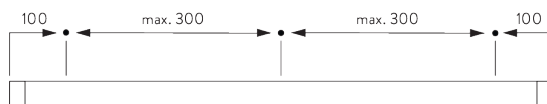

B. CEILING FITTING

Direct fitting

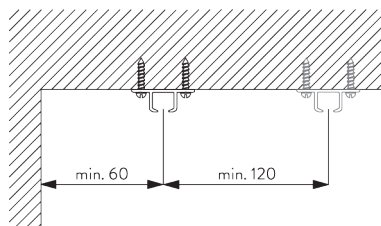

SYSTEM OPTIONS

A. WAVE

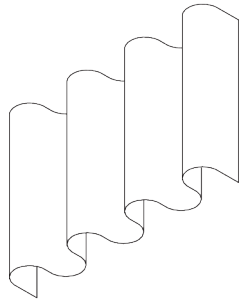

SG 11295

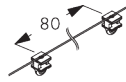

SG 11302



SG 2255



SG 2256

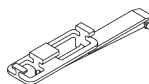

SG 6364



SG 6365

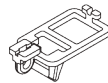

SG 6366

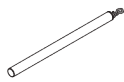

SG 10430-34

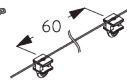

SG 11303

Standard components:

- SG 11295 End stop
- SG 11302 Wave 2C glider cord 80 mm

Optional components:

- SG 2255 Brake
- SG 2256 Brake
- SG 6364 Wave extension
- SG 6365 Wave hanger
- SG 6366 Wave carrier for draw rod
- SG 10430-34 Draw rod
- SG 11303 Wave 2C glider cord 60 mm



SG 3582

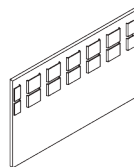

SG 6349

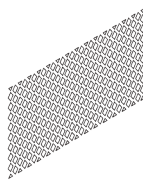

SG 6363

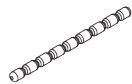

SG 10075



SG 10076

Curtain components:

- SG 3582 Hook
- SG 6349 Wave curtain tape
- SG 6363 Wave top hemming tape
- SG 10075 Lead weight 50 gr/m
- SG 10076 Fabric weight

Wave stack depth - 2C glider cord (standard components)

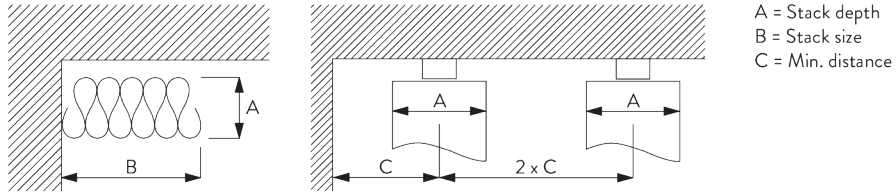





2C Glider cord SG 11302	Pockets between hooks	Approx. curtain fullness	Stack depth A	Stack size B*	Min distance C
80	6	~2.1	140	180 per metre of track	90
80	7	~2.3	160	180 per metre of track	100

2C Glider cord SG 11303	Pockets between hooks	Approx. curtain fullness	Stack depth A	Stack size B*	Min distance C
60	4	~2.1	100	230 per metre of track	70
60	5	~2.3	120	230 per metre of track	80





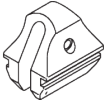





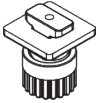

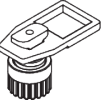



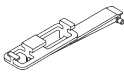

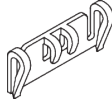

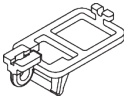

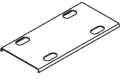
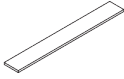
*Stack size B when using optional extension arm SG 6364 increases by 150 mm per curtain stack!

PARTS

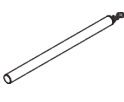
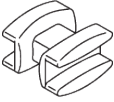
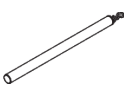
A. STANDARD PARTS

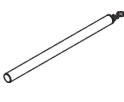
	SG 3599 Hook
	SG 6035p Profile
	SG 6065 End stop
	SG 6086 Spring stop
	SG 11300 2C glider

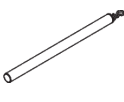
B. OPTIONAL PARTS

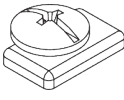
	SG 2255 Brake		SG 6283 Roller
	SG 2256 Brake		SG 6349 Wave curtain tape
	SG 3012 Hook		SG 6363 Wave top hemming tape
	SG 3571 Hook		SG 6364 Wave extension
	SG 3582 Hook		SG 6365 Wave hanger
	SG 6004 Eyelet		SG 6366 Wave carrier for draw rod
	SG 6005 Hook		SG 10075 Lead weight 50 g/m
	SG 6043 Connection bridge		SG 10076 Fabric weight
	SG 6053 Spring stop		SG 10430 Draw rod 50 cm
	SG 6057 Glider		SG 10431 Draw rod 75 cm
	SG 6082 Glider		SG 10432 Draw rod 100 cm
	SG 6094 Roller		SG 10433 Draw rod 125 cm
	SG 6098 Roller		SG 10434 Draw rod 150 cm
	SG 6240 Roller		SG 11295 End stop



SG 11301

2C glider on strip

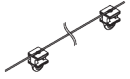

SG 11302

Wave 2C glider cord 80 mm

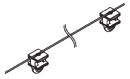

SG 11303

Wave 2C glider cord 60 mm



SG 11305

2C glider for direct sewing
