

# SG 6870

---

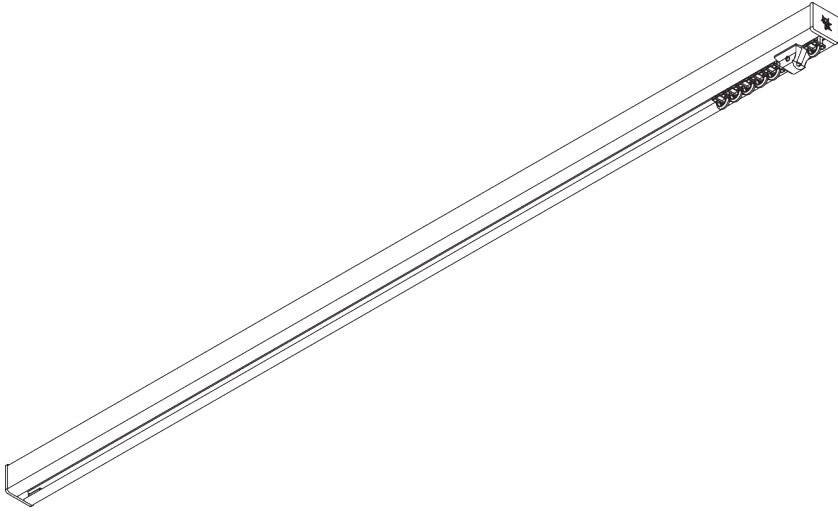

## PRODUCT INFORMATION

- **Operation:** hand
- **Range:** M - L
- **Fitting:** ceiling, wall, recess
- **Colours:** white RAL 9016, black RAL 9005 or anodised aluminum, special colours possible (recess profile only in white RAL 9016, black RAL 9005 or special color)
- **Fabrics:** refer to Silent Gliss fabric collection

### **Features:**

- 2-component (2C) glider technology
- Wave (2C)
- Bendable
- Bendable recess profile

# SYSTEM SPECIFICATIONS

## A. PROFILE

Profile and bending information

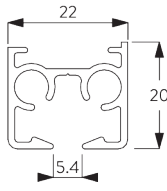

**SG 11190**

Profile

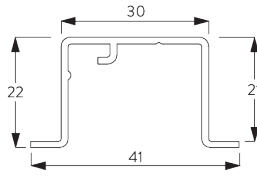

**SG 11230**

Recess profile



## B. HOW TO MEASURE

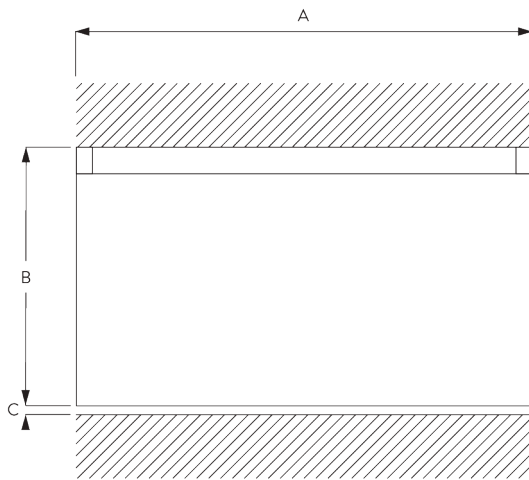

A: System width

B: System height

C: Distance between floor and fabric

## C. SPECIFICATION TEXT

### EN

Silent Gliss SG 6870 Hand Drawn Curtain Track System. Comprises aluminium profile SG 11190 supplied made to measure in silver anodised or white powder coated, alternatively a specified RAL colour. SG 11130 at 14/m, 2 end covers SG 11233 and 2 SG 6065 stops. Top fixed with brackets SG 3825/3826/3832 max. 500 mm centres. Wall fix SG Smart Fix at max. 500mm centres. Silent Gliss Wave option is available. Optional recess profile SG 11230.

### SV

Silent Gliss SG 6870 handdragssystem. Består av aluminiumprofil SG 11190 i specificerad längd i vitlack, alu natur eller angiven RAL färg. Kan användas med system Wave. 14 st SG 11300 SILENT TRACK glid per meter, 2 st SG 11233 ändskydd samt 2 st SG 6065 vridstopp per system. Takmonteras med fäste SG 3825/3826/3832 c/c 500 mm. Vägghmontering med SG Smart Fix c/c 500 mm. Kan kombineras med Wave. Kan levereras med infällningsprofil SG 11230.

### NO

Silent Gliss SG 6870 Manuell gardinskinne. Består av aluminiumprofil SG 11190 i spesifisert lengde, standard i hvitlakkert eller alu natur. Kan også leveres i spesifisert RAL farge. 14 stk SG 11300 SILENT TRACK glidere pr meter, 2 stk 11233 endeløkk og 2 stk SG 6065 vristopp pr system. Takmonteres med feste SG 3825/3826/3832 c/c 500mm. Veggmontering med SG Smart Fix c/c 500 mm. Kan kombineres med Wave system. Kan leveres med profil for innfelling SG 11230.

### DA

Silent Gliss SG 6870 håndtrukket gardinskinnesystem. Består af en aluminiumprofil SG 11190 i ønsket længde, sølvanodiseret eller hvid pulverlakering, alternativt en specificeret RAL-farve. 14 stk. SG 11300 glidere pr. m og 2 stk. SG 11233 endelæg samt 2 stk. SG 6065 endestop. Loftmonteres med beslagene SG 3825/3826/3832 med højst 500 mm afstand. Vægmonteres med SG Smart Fix med en afstand på højst 500 mm. Kan bruges med Silent Gliss Wave. Kan leveres med indfældningsprofil SG 11230.

# FITTING

## A. FITTING INFORMATION

For detailed fitting information, visit the Silent Gliss website.

### Fixing points

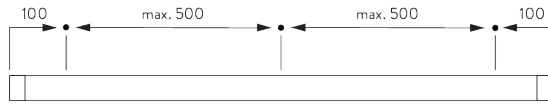

## B. CEILING FITTING

### Clamp SG 3825

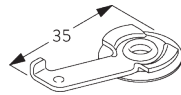
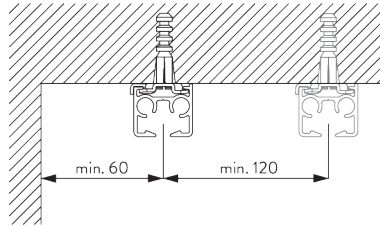

**SG 3825**  
Clamp

### Bracket SG 3826

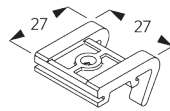
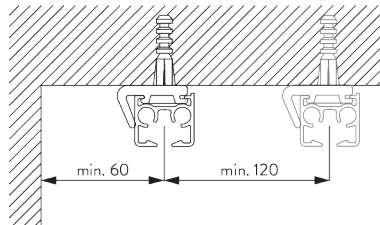

**SG 3826**  
Bracket

### Bracket SG 3832

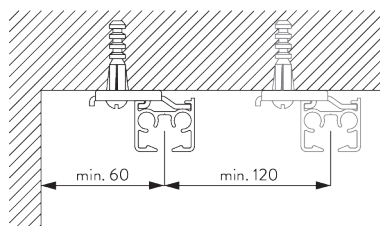

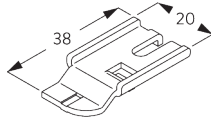

**SG 3832**

Bracket

## C. WALL FITTING

### Smart Fix

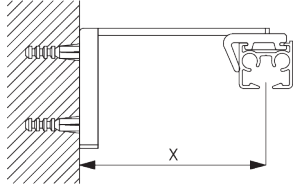

**Smart Fix SG 11200 - SG 11205 and bracket SG 3826:**

Screw SG 10492 (M4x8) needed.

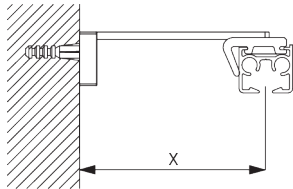

**Square Smart Fix SG 11210 - SG 11215 and bracket SG 3826:**

Screw SG 10492 (M4x8) needed.

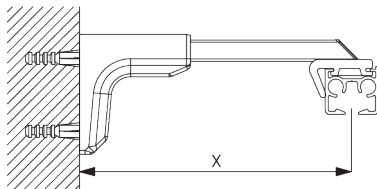

**Universal Smart Fix SG 11154 - SG 11156 and bracket SG 3826:**

Screw SG 10277 (M4x12) needed.

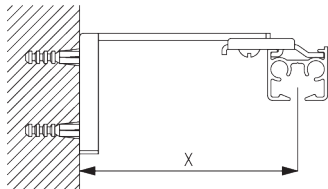

**Smart Fix SG 11200 - SG 11205 and bracket SG 3832:**

Screw SG 10492 (M4x8) needed.

Smart Fix	X mm (SG 3826 / SG 3825)	X mm (SG 3832)
SG 11200 / SG 11210	52	70
SG 11201 / SG 11211	72	90
SG 11202 / SG 11212	92	110
SG 11203 / SG 11213	112	130
SG 11204 / SG 11214	142	160
SG 11205 / SG 11215	192	210
SG 11154	102-130	120-148
SG 11155	132-160	150-178
SG 11156	182-210	200-228

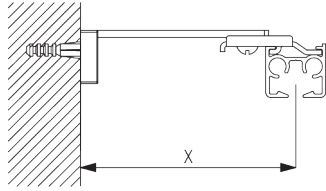

**Square Smart Fix SG 11210 - SG 11215 and bracket SG 3832:**  
Screw SG 10492 (M4x8) needed.

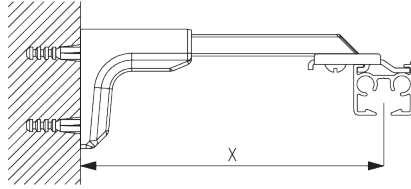

**Universal Smart Fix SG 11154 - SG 11156 and bracket SG 3832:**  
Screw SG 10407 (M4x10) needed.

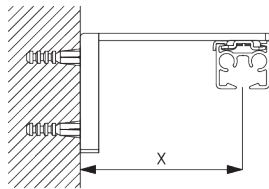

**Smart Fix SG 11200 - SG 11205 and clamp SG 3825:**  
Screw SG 10074 (M4x8) needed.

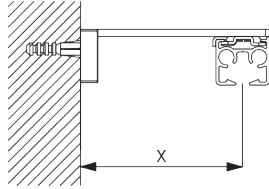

**Square Smart Fix SG 11210 - SG 11215 and clamp SG 3825:**  
Screw SG 10074 (M4x8) needed.

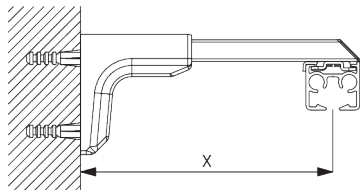

**Universal Smart Fix SG 11154 - SG 11156 and bracket SG 3825:**  
Screw SG 11158 (M4x12) needed.

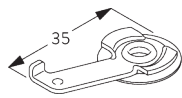

**SG 3825**  
Clamp

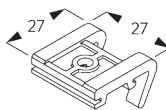

**SG 3826**  
Bracket

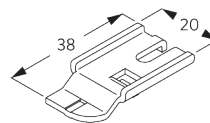

**SG 3832**  
Bracket



**SG 10074**  
Countersunk head screw  
M4x8



**SG 10277**

Pan head screw M4x12



**SG 10407**

Pan head screw M4x10



**SG 10492**

Pan head screw M4x8



**SG 11158**

Countersunk head screw  
M4x12

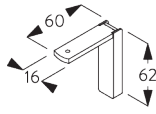

**SG 11200**

Smart Fix 60 mm

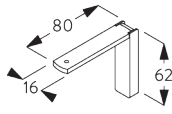

**SG 11201**

Smart Fix 80 mm

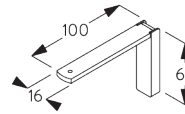

**SG 11202**

Smart Fix 100 mm

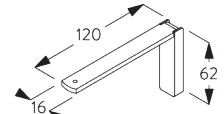

**SG 11203**

Smart Fix 120 mm

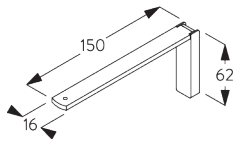

**SG 11204**

Smart Fix 150 mm

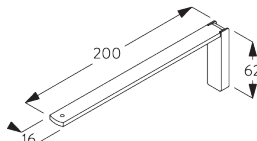

**SG 11205**

Smart Fix 200 mm

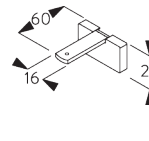

**SG 11210**

Square Smart Fix 60 mm

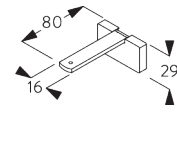

**SG 11211**

Square Smart Fix 80 mm

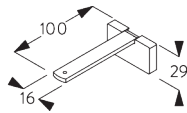

**SG 11212**

Square Smart Fix 100 mm

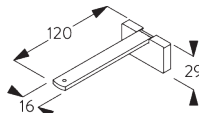

**SG 11213**

Square Smart Fix 120 mm

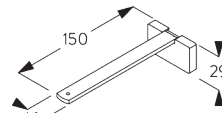

**SG 11214**

Square Smart Fix 150 mm

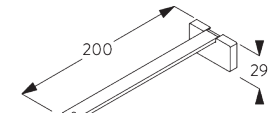

**SG 11215**

Square Smart Fix 200 mm

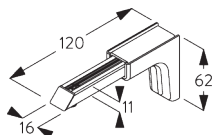

**SG 11154**

Universal Smart Fix 120 mm

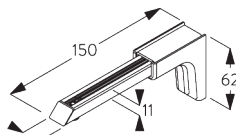

**SG 11155**

Universal Smart Fix 150 mm

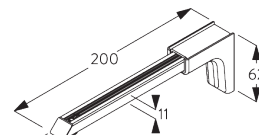

**SG 11156**

Universal Smart Fix 200 mm

## Bracket SG 3836

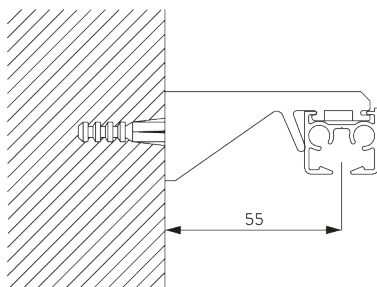

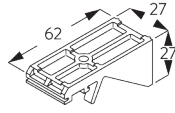

**SG 3836**  
Bracket

## D. RECESS FITTING

Recess profile  
SG 11230

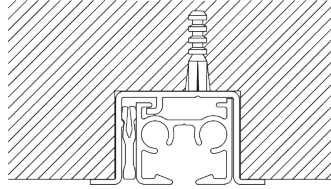

One wedge SG 10157 per fixing point.  
For detailed recess fitting, visit the Silent Gliss website.

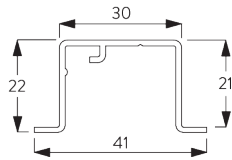

**SG 11230**  
Recess profile

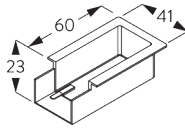

**SG 11238**  
Recess Mask

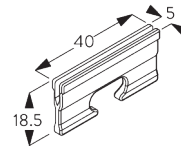

**SG 10157**  
Wedge

# SYSTEM OPTIONS

## A. WAVE

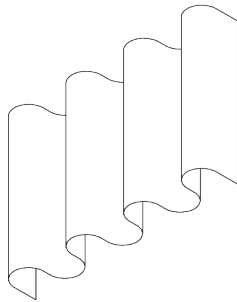

SG 11295

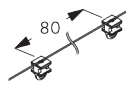

SG 11302

Standard components:

- SG 11295 End stop
- SG 11302 Wave 2C glider cord 80 mm

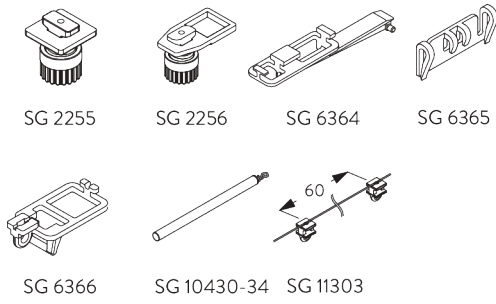

**Optional components:**

- SG 2255 Brake
- SG 2256 Brake
- SG 6364 Wave extension
- SG 6365 Wave hanger
- SG 6366 Wave carrier for draw rod
- SG 10430-34 Draw rod
- SG 11303 Wave 2C glider cord 60 mm

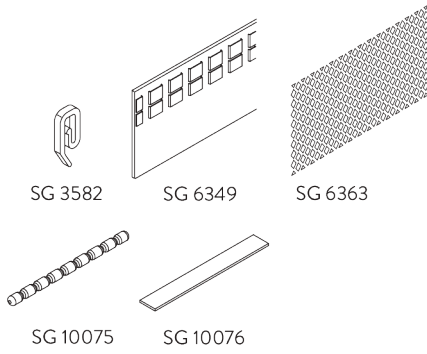

**Curtain components:**

- SG 3582 Hook
- SG 6349 Wave curtain tape
- SG 6363 Wave top hemming tape
- SG 10075 Lead weight 50 gr/m
- SG 10076 Fabric weight

**Wave stack depth - 2C glider cord (standard components)**

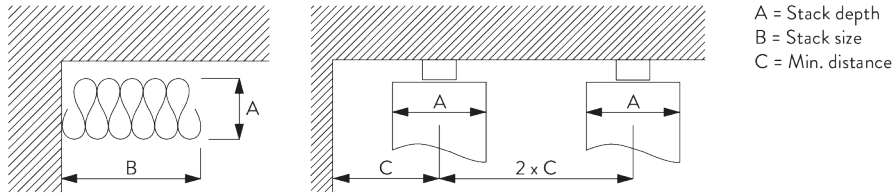

A = Stack depth  
 B = Stack size  
 C = Min. distance

2C Glider cord SG 11302	Pockets between hooks	Approx. curtain fullness	Stack depth A	Stack size B*	Min distance C
80	6	~2.1	140	180 per metre of track	90
80	7	~2.3	160	180 per metre of track	100







2C Glider cord SG 11303	Pockets between hooks	Approx. curtain fullness	Stack depth A	Stack size B*	Min distance C
60	4	~2.1	100	230 per metre of track	70
60	5	~2.3	120	230 per metre of track	80

\*Stack size B when using optional extension arm increases by 150 mm per curtain stack!



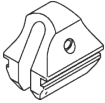







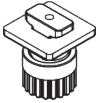

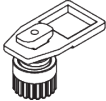

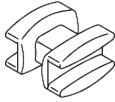





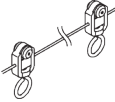
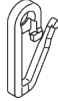



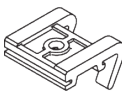

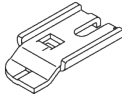
# PARTS

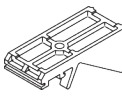
## A. STANDARD PARTS

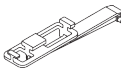
	<b>SG 3599</b> Hook
	<b>SG 3825</b> Clamp
	<b>SG 6065</b> End stop
	<b>SG 6086</b> Spring stop
	<b>SG 11190</b> Profile
	<b>SG 11233</b> End cover
	<b>SG 11300</b> 2C glider

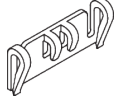
## B. OPTIONAL PARTS

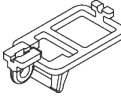
	<b>SG 2255</b> Brake		<b>SG 6057</b> Glider
	<b>SG 2256</b> Brake		<b>SG 6064</b> End stop
	<b>SG 3012</b> Hook		<b>SG 6082</b> Glider
	<b>SG 3555</b> Hook		<b>SG 6094</b> Roller
	<b>SG 3581</b> Hook		<b>SG 6098</b> Roller
	<b>SG 3582</b> Hook		<b>SG 6099</b> Wave roller cord 80 mm
	<b>SG 3598</b> Eyelet		<b>SG 6146</b> Hook
	<b>SG 3802</b> Connection bridge		<b>SG 6240</b> Roller
	<b>SG 3826</b> Bracket		<b>SG 6283</b> Roller
	<b>SG 3832</b> Bracket		<b>SG 6349</b> Wave curtain tape
	<b>SG 3836</b> Bracket		<b>SG 6363</b> Wave top hemming tape
	<b>SG 6004</b> Eyelet		<b>SG 6364</b> Wave extension
	<b>SG 6005</b> Hook		<b>SG 6365</b> Wave hanger
	<b>SG 6053</b> Spring stop		<b>SG 6366</b> Wave carrier for draw rod

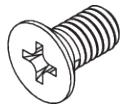
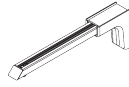
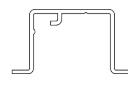
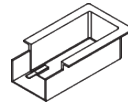
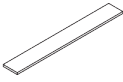
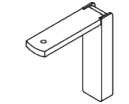
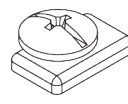
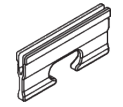
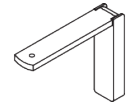
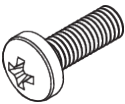
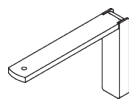
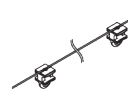
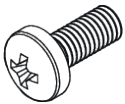
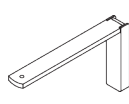
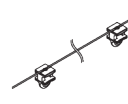
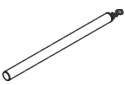
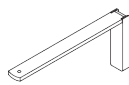
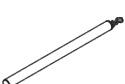
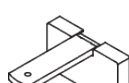
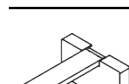
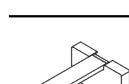
**SG 10074***Countersunk head screw M4x8***SG 11156***Universal Smart Fix 200 mm***SG 11230***Recess profile***SG 10075***Lead weight 50 g/m***SG 11158***Countersunk head screw M4x12***SG 11238***Recess Mask***SG 10076***Fabric weight***SG 11200***Smart Fix 60 mm***SG 11295***End stop***SG 10157***Wedge***SG 11201***Smart Fix 80 mm***SG 11301***2C glider on strip***SG 10277***Pan head screw M4x12***SG 11202***Smart Fix 100 mm***SG 11302***Wave 2C glider cord 80 mm***SG 10407***Pan head screw M4x10***SG 11203***Smart Fix 120 mm***SG 11303***Wave 2C glider cord 60 mm***SG 10430***Draw rod 50 cm***SG 11204***Smart Fix 150 mm***SG 11305***2C glider for direct sewing***SG 10431***Draw rod 75 cm***SG 11205***Smart Fix 200 mm***SG 10432***Draw rod 100 cm***SG 11210***Square Smart Fix 60 mm***SG 10433***Draw rod 125 cm***SG 11211***Square Smart Fix 80 mm***SG 10434***Draw rod 150 cm***SG 11212***Square Smart Fix 100 mm***SG 10492***Pan head screw M4x8***SG 11213***Square Smart Fix 120 mm***SG 11154***Universal Smart Fix 120 mm***SG 11214***Square Smart Fix 150 mm***SG 11155***Universal Smart Fix 150 mm***SG 11215***Square Smart Fix 200 mm*



