

# SG 6970

---

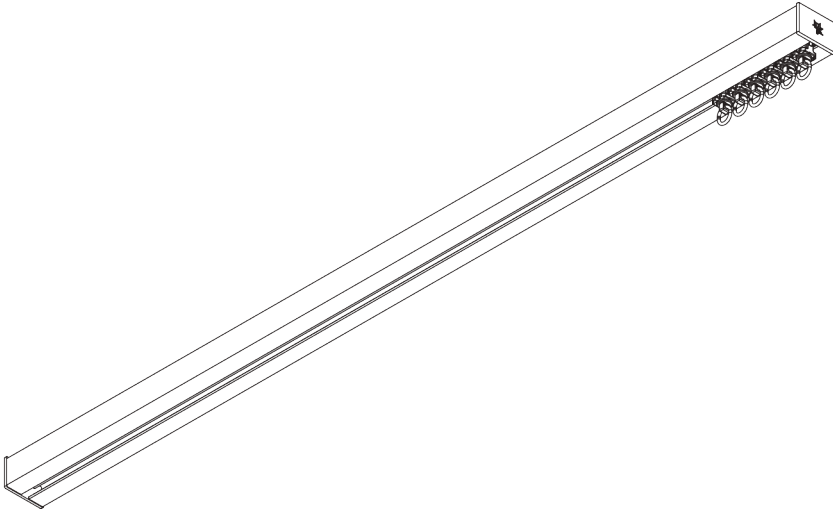

## PRODUCT INFORMATION

- **Operation:** hand
- **Range:** M - L
- **Fitting:** ceiling, wall, recess
- **Colours:** white RAL 9016, black RAL 9005 or anodised aluminum, special colours possible (recess profile only in white RAL 9016, black RAL 9005 or special color)
- **Fabrics:** refer to Silent Gliss fabric collection

### **Features:**

- 2-component (2C) roller technology
- Wave (2C)
- Bendable
- Bendable recess profile

# SYSTEM SPECIFICATIONS

## A. PROFILE

### Profile and bending information

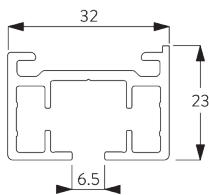

#### SG 10850

Profile

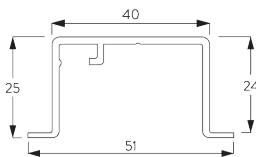

#### SG 10862

Recess profile



## B. HOW TO MEASURE

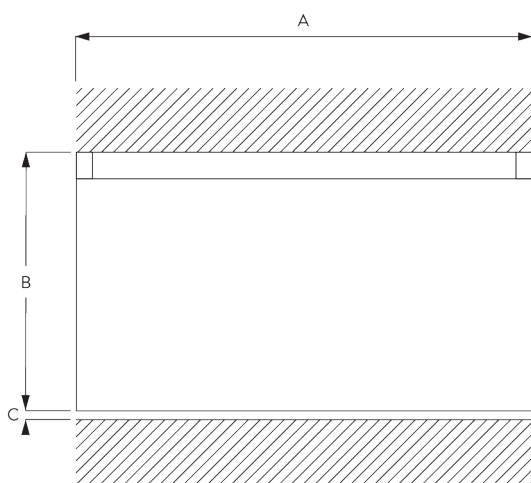

A: System width

B: System height

C: Distance between floor and fabric

## C. SPECIFICATION TEXT

### EN

Silent Gliss SG 6970 Hand Drawn Curtain Track System. Comprises aluminium profile SG 10850 supplied made to measure in silver anodised or white powder coated, alternatively a specified RAL colour. SG 10840 at 10/m, 2 end covers SG 11235. Top fixed with brackets SG 3004/3041 max. 500 mm centres. Wall fix SG Smart Fix at max. 500 mm centres. Optional recess profile SG 10862. Silent Gliss Wave option is available.

### SV

Silent Gliss SG 6970 handdragssystem. Består av aluminiumprofil SG 10850 i specificerad längd i vitlack, alu natur eller angiven RAL färg. 10 st SG 10840 glid per meter, 2 st SG 11235 ändskydd per system. Takmonteras med fäste SG 3004/3041 c/c 500 mm. Vägmontering med SG Smart Fix c/c 500 mm. Kan levereras med infällningsprofil SG 10862. Kan användas med system Wave.

### NO

Silent Gliss SG 6970 Manuell gardinskinne. Består av aluminiumprofil SG 10850 i spesifisert lengde, standard i hvitlakkert eller alu natur. Kan også leveres i spesifisert RAL farge. 10 stk SG 10840 glidere pr meter, 2 stk 11235 endeløkk pr system. Takmonteres med feste SG 3004/3041 c/c 500 mm. Veggmontering med SG Smartfix c/c 500 mm. Kan leveres med profil for innfelling SG 10862. Kan kombineres med Wave system.

### DA

Silent Gliss SG 6970 håndtrukket gardinskinnesystem. Består af en aluminiumprofil SG 10850 i ønsket længde, sølvanodiseret eller hvid pulverlakering, alternativt en specificeret RAL-farve. 10 stk. SG 10840 pr. m og 2 stk. SG 11235 endelåg. Loftmonteres med beslagene SG 3004/3041 højst 500 mm afstand. Vægmonteres med SG Smart Fix med en afstand på højst 500 mm. Kan leveres med indfældningsprofil SG 10862. Kan bruges med Silent Gliss Wave.

# FITTING

## A. FITTING INFORMATION

For detailed fitting information, visit the *Silent Gliss* website.

### Fixing points

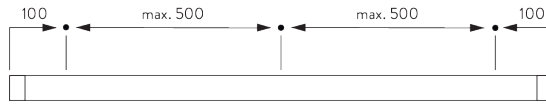

## B. CEILING FITTING

### Clamp SG 3004

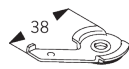
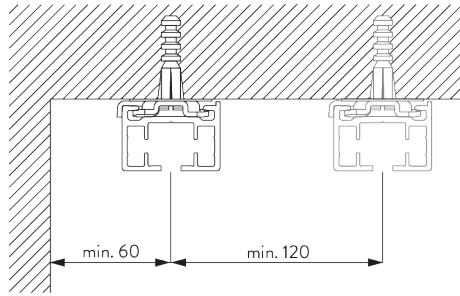

**SG 3004**

Clamp

### Direct fitting

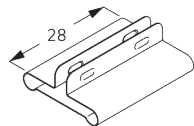
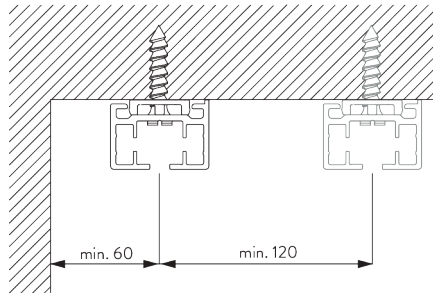

**SG 7002**

Profile protector

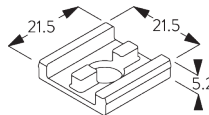

**SG 10865**

Support plate

## Bracket SG 3041

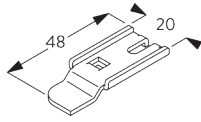
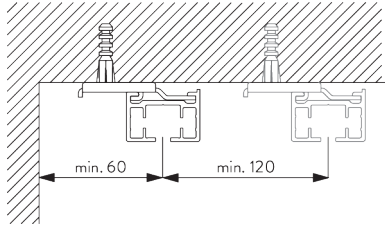

**SG 3041**

Bracket

## C. WALL FITTING

### Smart Fix

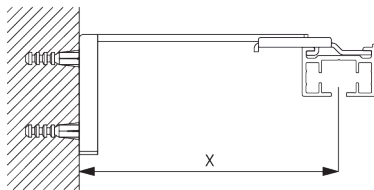

**Smart Fix SG 11200 - SG 11205 and bracket SG 3041:**  
Screw SG 10492 (M4x8) needed.

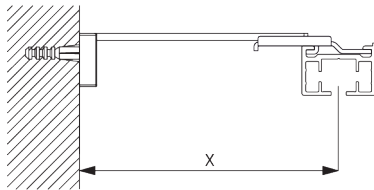

**Square Smart Fix SG 11210 - SG 11215 and bracket SG 3041:**  
Screw SG 10492 (M4x8) needed.

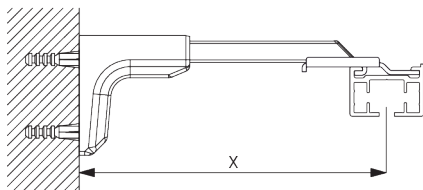

**Universal Smart Fix SG 11154 - SG 11156 and bracket SG 3041:**  
Screw SG 10407 (M4x10) needed.

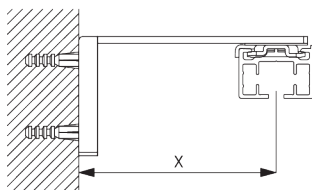

**Smart Fix SG 11201 - SG 11205 and clamp SG 3004:**  
Screw SG 10074 (M4x8) needed.

Smart Fix	X mm (SG 3041)	X mm (SG 3004)
SG 11200 / SG 11210	83	
SG 11201 / SG 11211	103	72
SG 11202 / SG 11212	123	92
SG 11203 / SG 11213	143	112
SG 11204 / SG 11214	173	142
SG 11205 / SG 11215	223	192
SG 11154	128-156	102-130
SG 11155	158-186	132-160
SG 11156	208-236	182-210

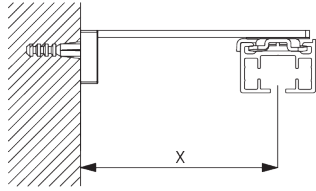

**Square Smart Fix SG 11211 - SG 11215 and clamp  
SG 3004:**

Screw SG 10074 (M4x8) needed.

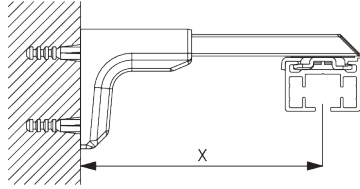

**Universal Smart Fix SG 11154 - SG 11156 and clamp  
SG 3004:**

Screw SG 11158 (M4x12) needed.

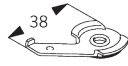

**SG 3004**  
Clamp

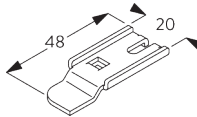

**SG 3041**  
Bracket



**SG 10074**  
Countersunk head screw  
M4x8



**SG 10407**  
Pan head screw M4x10



**SG 10492**  
Pan head screw M4x8



**SG 11158**  
Countersunk head screw  
M4x12

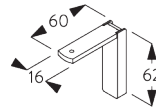

**SG 11200**  
Smart Fix 60 mm

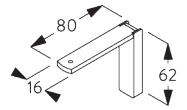

**SG 11201**  
Smart Fix 80 mm

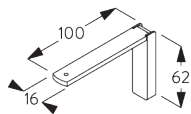

**SG 11202**  
Smart Fix 100 mm

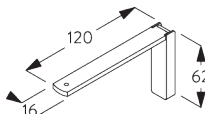

**SG 11203**  
Smart Fix 120 mm

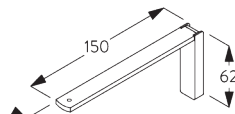

**SG 11204**  
Smart Fix 150 mm

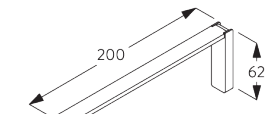

**SG 11205**  
Smart Fix 200 mm

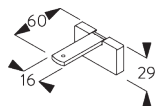

**SG 11210**  
Square Smart Fix 60 mm

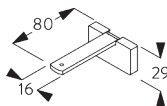

**SG 11211**  
Square Smart Fix 80 mm

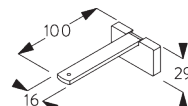

**SG 11212**  
Square Smart Fix 100 mm

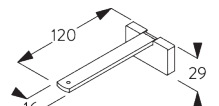

**SG 11213**  
Square Smart Fix 120 mm

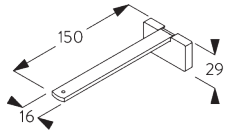

**SG 11214**  
Square Smart Fix 150 mm

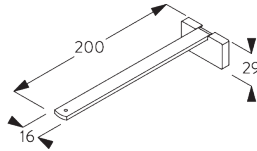

**SG 11215**  
Square Smart Fix 200 mm

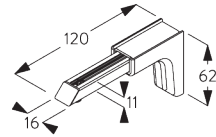

**SG 11154**  
Universal Smart Fix 120 mm

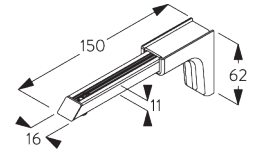

**SG 11155**  
Universal Smart Fix 150 mm

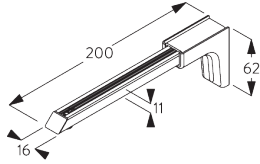

**SG 11156**  
Universal Smart Fix 200 mm

## D. RECESS FITTING

### Recess profile SG 10862

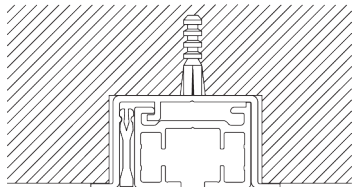

One wedge SG 5118 per fixing point.  
For detailed recess fitting, visit the Silent Gliss website.

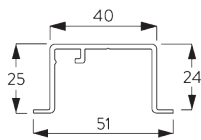

**SG 10862**  
Recess profile

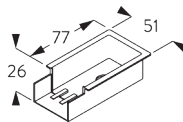

**SG 10864**  
Recess mask

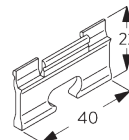

**SG 5118**  
Wedge

## E. SUSPENDED FITTING

### Hanger SG 6105

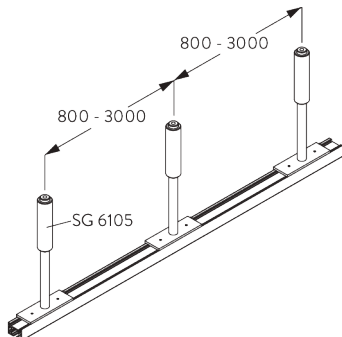

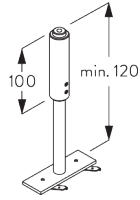

**SG 6105**  
Hanger with plate

## V-hanger SG 6107

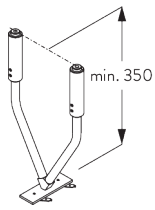
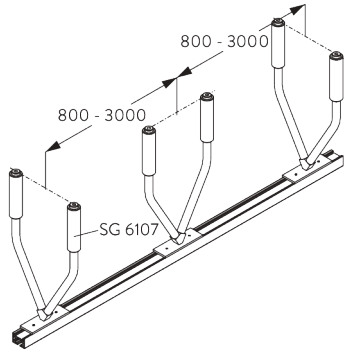

**SG 6107**  
V-Hanger with plate

# SYSTEM OPTIONS

## A. WAVE

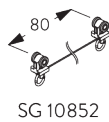
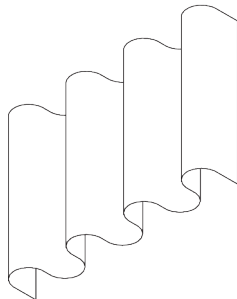

Standard components:

- SG 11295 End stop
- SG 10852 Wave 2C roller cord 80 mm

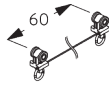

SG 10869

Optional components:

- SG 10869 Wave 2C roller cord 60 mm

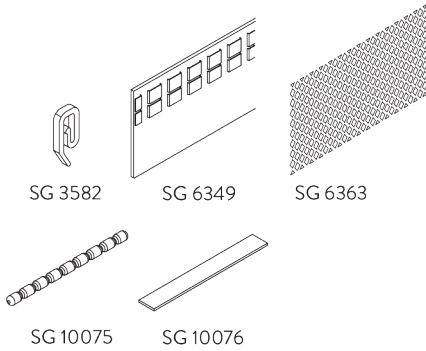

Curtain components:

- SG 3582 Hook
- SG 6349 Wave curtain tape
- SG 6363 Wave top hemming tape
- SG 10075 Lead weight 50 gr/m
- SG 10076 Fabric weight

Wave stack depth - 2C roller cord (standard components)

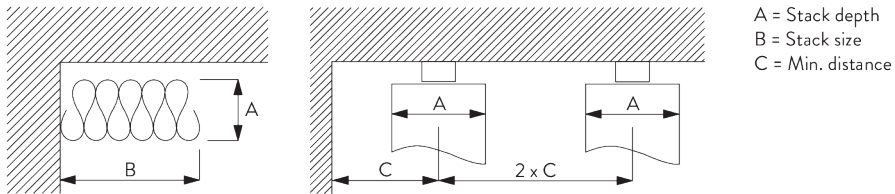

A = Stack depth  
B = Stack size  
C = Min. distance



2C Roller cord SG 10852	Pockets between hooks	Approx. curtain fullness	Stack depth A	Stack size B	Min distance C
80	6	~2.1	140	210 per metre of track	90
80	7	~2.3	160	210 per metre of track	100

2C Roller cord SG 10869	Pockets between hooks	Approx. curtain fullness	Stack depth A	Stack size B	Min distance C
60	4	~2.1	100	260 per metre of track	70
60	5	~2.3	120	260 per metre of track	80





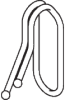

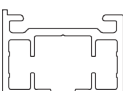
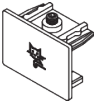
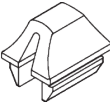





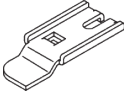
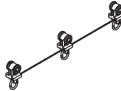

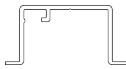
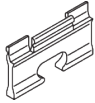
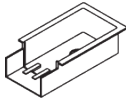
# PARTS

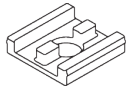
## A. STANDARD PARTS

	<b>SG 3004</b> Clamp
	<b>SG 3581</b> Hook
	<b>SG 10840</b> 2C roller
	<b>SG 10850</b> Profile
	<b>SG 11235</b> End cover
	<b>SG 11465</b> Spring stop

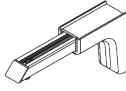
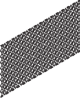
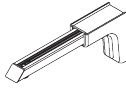
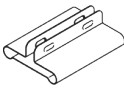
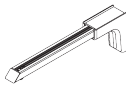
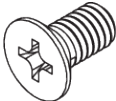
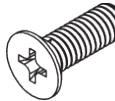
## B. OPTIONAL PARTS

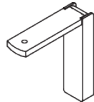
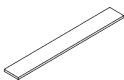
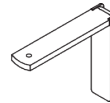
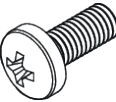
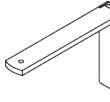
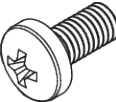
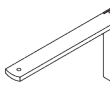
	<b>SG 3012</b> Hook		<b>SG 10831</b> Connection bridge
	<b>SG 3041</b> Bracket		<b>SG 10852</b> Wave 2C roller cord 80 mm
	<b>SG 3582</b> Hook		<b>SG 10862</b> Recess profile
	<b>SG 5118</b> Wedge		<b>SG 10864</b> Recess mask
	<b>SG 6105</b> Hanger with plate		<b>SG 10865</b> Support plate
	<b>SG 6107</b> V-Hanger with plate		<b>SG 10869</b> Wave 2C roller cord 60 mm
	<b>SG 6349</b> Wave curtain tape		<b>SG 11154</b> Universal Smart Fix 120 mm
	<b>SG 6363</b> Wave top hemming tape		<b>SG 11155</b> Universal Smart Fix 150 mm
	<b>SG 7002</b> Profile protector		<b>SG 11156</b> Universal Smart Fix 200 mm
	<b>SG 10074</b> Countersunk head screw M4x8		<b>SG 11158</b> Countersunk head screw M4x12
	<b>SG 10075</b> Lead weight 50 g/m		<b>SG 11200</b> Smart Fix 60 mm
	<b>SG 10076</b> Fabric weight		<b>SG 11201</b> Smart Fix 80 mm
	<b>SG 10407</b> Pan head screw M4x10		<b>SG 11202</b> Smart Fix 100 mm
	<b>SG 10492</b> Pan head screw M4x8		<b>SG 11203</b> Smart Fix 120 mm

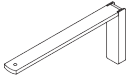

**SG 11204**

Smart Fix 150 mm

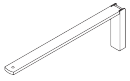

**SG 11205**

Smart Fix 200 mm

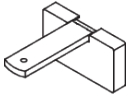

**SG 11210**

Square Smart Fix 60 mm

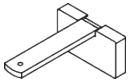

**SG 11211**

Square Smart Fix 80 mm

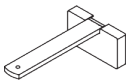

**SG 11212**

Square Smart Fix 100 mm

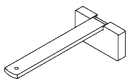

**SG 11213**

Square Smart Fix 120 mm

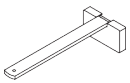

**SG 11214**

Square Smart Fix 150 mm

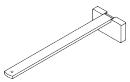

**SG 11215**

Square Smart Fix 200 mm

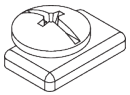

**SG 11295**

End stop



