

# SG 7610

---

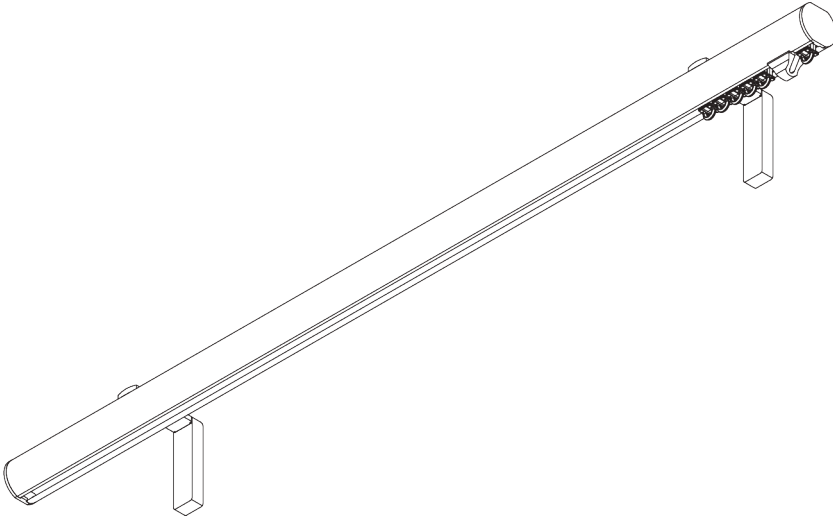
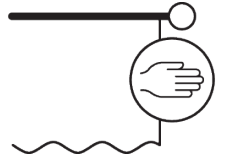

## PRODUCT INFORMATION

- **Operation:** hand
- **Range:** S - M
- **Fitting:** ceiling, wall
- **Colours:** white RAL 9016, various colours / finishes
- **Fabrics:** refer to Silent Gliss fabric collection

### **Features:**

- 2-component (2C) glider technology
- Wave (2C)
- Matching endcaps and brackets / bracket covers
- Range of decorative finials
- Bendable

# SYSTEM SPECIFICATIONS

## A. PROFILE

Profile and bending information

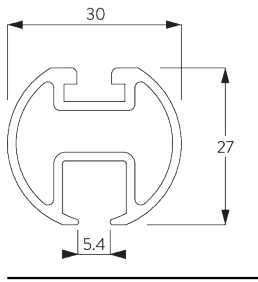

SG 6103p

Profile



## B. HOW TO MEASURE

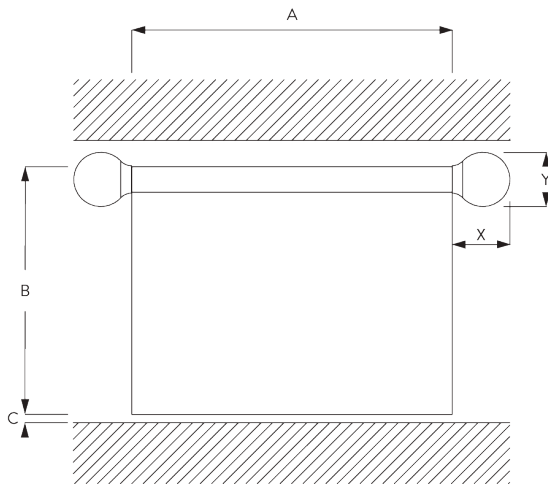

A: System width without finials







B: System height

C: Distance between floor and fabric

X: Finial width

Y: Finial height

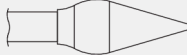
## Finial Measurements

		30 mm	
		X	Y
	SG 11603	2	30
	SG 11631	10	34
	SG 11632	18	50
	SG 11746	64	60
	SG 11747	116	48
	SG 11748	26	90
	SG 11749	20	60

## C. SPECIFICATION

### TEXT

### SV

Silent Gliss SG 7610 Metropole handdragssystem, består av 30mm rund aluminiumprofil SG 6103, levereras i specificerade längder. 14 st 2C glid SG 11300 per meter, 2 st vridstopp SG 6065, 2st ändskydd SG 11603. Raka profiler levereras som standard med väggvinkel "Smart Fix" SG 11206. Alternativ väggvinkel Smart Fix SG11207-11208/ Smart Fix Square SG 11216-11218 eller Fillet SG 11669. Takbeslag SG 11668 eller minihängare SG 6175, samtliga beslag monteras c/c 600mm. Profil och beslag lackeras i Vit, Matt vit, Silver, Taupe, Antique bronze, Svart, Charcoal eller Bronze, ändskydd levereras i matchande färg. Wave finns som alternativ. Wave 2C glid 60 mm SG 11303 / 80 mm SG 11302. Levereras som standard med stoppskruv SG 11295. Alternativt rullglid med krok SG 6094/ rullglid med ögla SG 6098.

### NO

Silent Gliss SG 7610 Metropole håndført gardinskinnesystem. Består av 30 mm rund aluminiumsprofil SG 6103 i spesifiserte lengder med 14 stk 2C glider SG 11300 pr. meter, 2 stk SG 6065 vristopper og 2 stk Flush endeløkk SG 11603. Rette system leveres som standard med veggvinkel Smart Fix SG 11206 hver 600 mm. Alternative veggvinkler Smart Fix SG 11207-11208 / Square Smart Fix SG 11216-11218 eller Fillet brakett SG 11669. Alternative takfester er Top Fix SG 11668 eller Mini-henger SG 6175, alle fester monteres c/c 600 mm. Farger: White, Matt White, Silver, Taupe, Antique Bronze, Bronze, Charcoal og matt Black. Endedekor: Flush, Stud, Design, Ball, Taper, Ellipse og Spear. Alternativ med Wave 80 mm 2C glider SG 11302 eller 60 mm SG 11303. Leveres som standard med stoppskrue SG 11295. Kan også leveres med rulleglider med krok SG 6094 / rulleglider med øye SG 6098.

### DA

Silent Gliss SG 7610 Metropole håndtrukket gardinskinnesystem. Består af en 30 mm aluminiumsprofil SG 6103 i ønsket længde med 14 stk 2C glidere SG 11300 pr. meter, 2 stk SG 6065 endestop og 2 stk Flush endelæg SG 11603. Leveres som standard med 60 mm vægvinkel Smart Fix SG 11206 for hver 600 mm. Alternative vægvinkler Smart Fix SG 11207-11208 / Square Smart Fix SG 11216-11218 eller Fillet vinkel SG 11669. Alternative loftbeslag er Top Fix SG 11668 eller Mini hanger SG 6175, alle beslag monteres c/c 600 mm. Farver: White, Matt White, Silver, Taupe, Antique Bronze, Bronze, Charcoal og Black. Endedekor: Flush, Stud, Design, Ball, Taper, Ellipse og Spear. Alternativ med Wave 80 mm 2C glider SG 11302 eller 60 mm SG 11303. Leveres som standard med stoppskrue SG 11295. Kan også leveres med rulleglider med krog SG 6094 / rulleglider med øje SG 6098.

# FITTING

## A. FITTING INFORMATION

For detailed fitting information, visit the *Silent Gliss* website.

### Fixing points

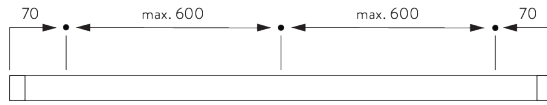

## B. CEILING FITTING

### Top fix bracket SG 11668

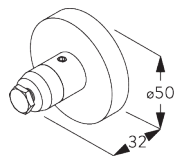
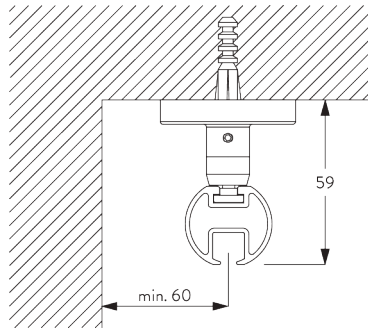

**SG 11668**

*Top fix bracket*

### Mini hanger SG 6175

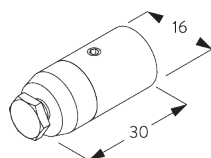
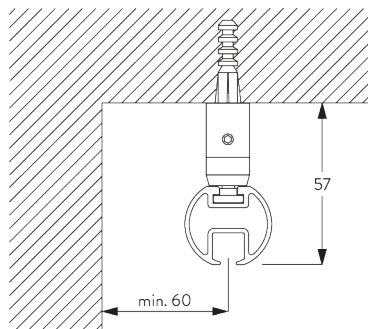

**SG 6175**

*Mini hanger*

## C. WALL FITTING

### Smart Fix

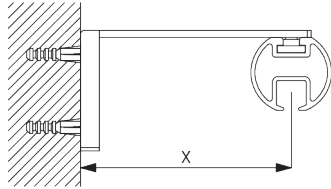

**Smart Fix with slot SG 11206 - SG 11208 and SG 6141:**  
Screw SG 10492 (M4x8) needed.

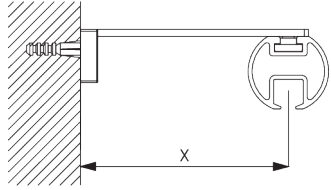

**Square Smart Fix with slot SG 11216 - SG 11218 and SG 6141:**  
Screw SG 10492 (M4x8) needed.

Smart Fix	X mm
SG 11206 / SG 11216	51
SG 11207 / SG 11217	71
SG 11208 / SG 11218	91

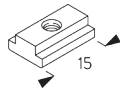

**SG 6141**  
Clamping piece



**SG 10492**  
Pan head screw M4x8

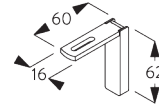

**SG 11206**  
Smart Fix with slot 60 mm

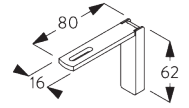

**SG 11207**  
Smart Fix with slot 80 mm

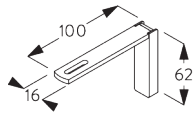

**SG 11208**  
Smart Fix with slot 100 mm

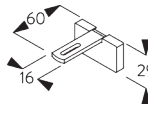

**SG 11216**  
Square Smart Fix with slot 60 mm

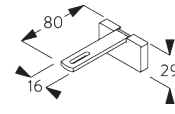

**SG 11217**  
Square Smart Fix with slot 80 mm

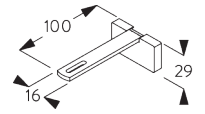

**SG 11218**  
Square Smart Fix with slot 100 mm

### Fillet Bracket SG 11669

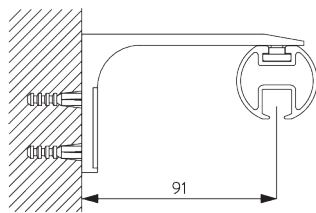

Screw SG 10492 (M4x8) needed.  
Recommended for straight systems only.

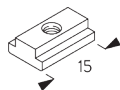

**SG 6141**  
Clamping piece



**SG 10492**  
Pan head screw M4x8

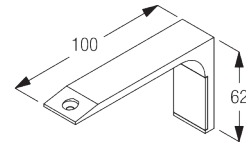

**SG 11669**  
Fillet bracket

# DESIGN & SYSTEM OPTIONS

## A. ENDCAPS



Endcaps:

- SG 11603 Flush endcap 30 mm
- SG 11631 Stud endcap 30 mm
- SG 11632 Design endcap 30 mm

Please note:

- Without finials, poles are supplied as standard with flush fitting endcaps SG 11603 (left).
- Alternatively, stud endcaps SG 11631 can be selected at no additional cost.

## B. FINIALS

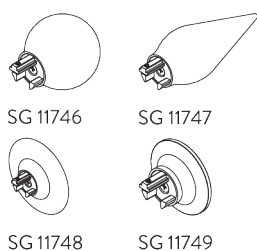

Finials are decorative elements that fit on at the end of the pole:

- SG 11746 Ball end 30 mm
- SG 11747 Spear 30 mm
- SG 11748 Ellipse 30 mm
- SG 11749 Taper 30 mm

## C. WAVE

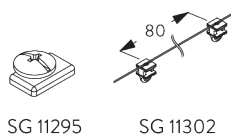
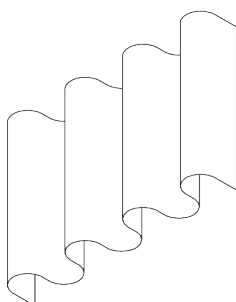

Standard components:

- SG 11295 End stop
- SG 11302 Wave 2C glider cord 80 mm

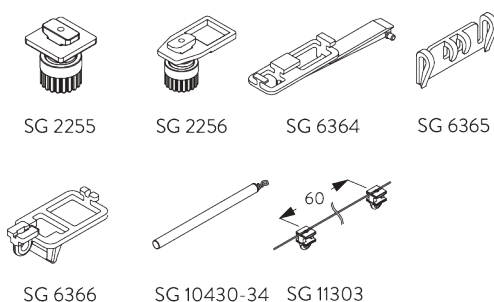

Optional components:

- SG 2255 Brake
- SG 2256 Brake
- SG 6364 Wave extension
- SG 6365 Wave hanger
- SG 6366 Wave carrier for draw rod
- SG 10430-34 Draw rod
- SG 11303 Wave 2C glider cord 60 mm

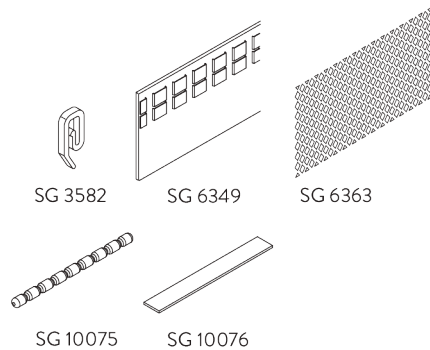

Curtain components:

- SG 3582 Hook
- SG 6349 Wave curtain tape
- SG 6363 Wave top hemming tape
- SG 10075 Lead weight 50 gr/m
- SG 10076 Fabric weigh

Wave stack depth - 2C glider cord (standard components)

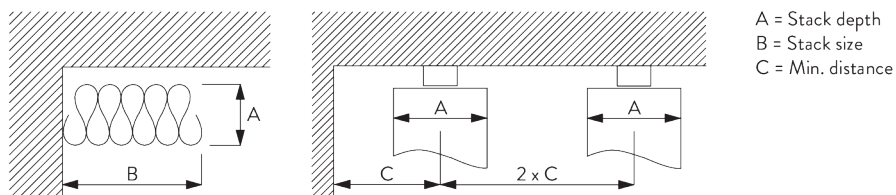

2C Glider cord SG 11302	Pockets between hooks	Approx. curtain fullness	Stack depth A	Stack size B*	Min distance C
80	6	~2.1	140	180 per metre of track	90
80	7	~2.3	160	180 per metre of track	100

2C Glider cord SG 11303	Pockets between hooks	Approx. curtain fullness	Stack depth A	Stack size B*	Min distance C
60	4	~2.1	100	230 per metre of track	70
60	5	~2.3	120	230 per metre of track	80

\*Stack size B when using optional extension arm SG 6364 increases by 95 mm per curtain stack!

# PARTS

## A. STANDARD PARTS



**SG 6065**

End stop

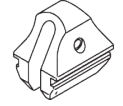

**SG 6086**

Spring stop



**SG 6103p**

Profile

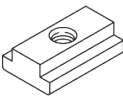

**SG 6141**

Clamping piece



**SG 10492**

Pan head screw M4x8

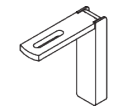

**SG 11206**

Smart Fix with slot 60 mm

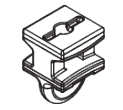

**SG 11300**

2C glider



**SG 11603**

Flush end cap 30 mm

## B. OPTIONAL PARTS

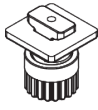

**SG 2255**

Brake

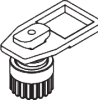

**SG 2256**

Brake

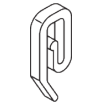

**SG 3582**

Hook



**SG 3599**

Hook



**SG 6094**

Roller



**SG 6098**

Roller

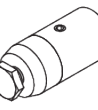

**SG 6175**

Mini hanger



**SG 6283**

Roller



**SG 6349**

Wave curtain tape

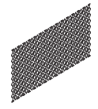

**SG 6363**

Wave top hemming tape

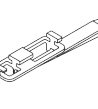

**SG 6364**

Wave extension

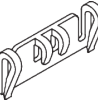

**SG 6365**

Wave hanger

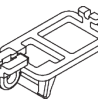

**SG 6366**

Wave carrier for draw rod

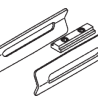

**SG 6635**

Connection bridge set



**SG 10075**

Lead weight 50 g/m

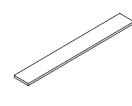

**SG 10076**

Fabric weight



**SG 10430**

Draw rod 50 cm

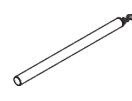

**SG 10431**

Draw rod 75 cm

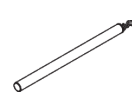

**SG 10432**

Draw rod 100 cm

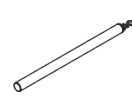

**SG 10433**

Draw rod 125 cm



**SG 10434**

Draw rod 150 cm

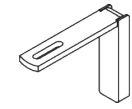

**SG 11207**

Smart Fix with slot 80 mm

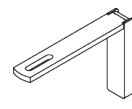

**SG 11208**

Smart Fix with slot 100 mm

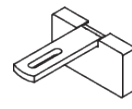

**SG 11216**

Square Smart Fix with slot 60 mm

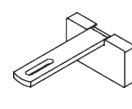

**SG 11217**

Square Smart Fix with slot 80 mm

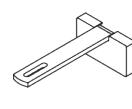

**SG 11218**

Square Smart Fix with slot 100 mm

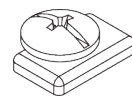

**SG 11295**

End stop



**SG 11301**

2C glider on strip



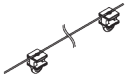

---

**SG 11302**  
*Wave 2C glider cord 80 mm*

---

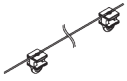

---

**SG 11303**  
*Wave 2C glider cord 60 mm*

---



---

**SG 11631**  
*Stud end cap 30 mm*

---



---

**SG 11632**  
*Design end cap 30 mm*

---

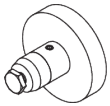

---

**SG 11668**  
*Top fix bracket*

---

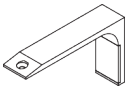

---

**SG 11669**  
*Fillet bracket*

---

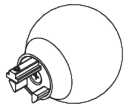

---

**SG 11746**  
*Ball end 30 mm*

---



---

**SG 11747**  
*Spear 30 mm*

---



---

**SG 11748**  
*Ellipse 30 mm*

---

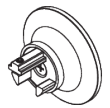

---

**SG 11749**  
*Taper 30 mm*

---





